

510 FT
Pag 151

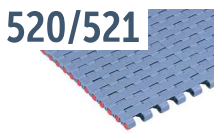

520 FT
Pag 153

520 FTT
Pag 154

520 FG
Pag 155

520 GT
Pag 156

520 LBP
Pag 157

521 FT
Pag 158

228 Transfer plate
Pag 159/160

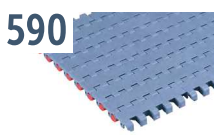

590 FT
Pag 162

590 FT One track Belt
Pag 163

590 FTT
Pag 164

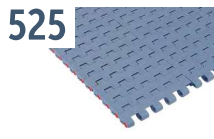

525 FT
Pag 166

525 FTT
Pag 167

525 GT
Pag 168

525 GT Side indent
Pag 169

525 HD FT
Pag 170

525 HD FG
Pag 171

525 HD GT
Pag 172

525 HD GT Side indent
Pag 173

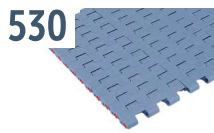

530 FT
Pag 175

530 FTT
Pag 176

530 GT
Pag 177

530 GT Side indent
Pag 178

530 LBP
Pag 179

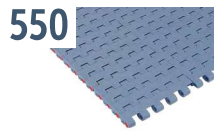

550 FT
Pag 181

550 FT One track Belt
Pag 182

550 FTT
Pag 183

550 FG
Pag 184

550 FG One track Belt
Pag 185

550 GT
Pag 186

550 GT Side indent
Pag 187

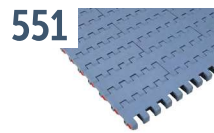

551 FT
Pag 189

551 FTT
Pag 190

551 GT
Pag 191

551 GT Side indent
Pag 192

551 LBP
Pag 193

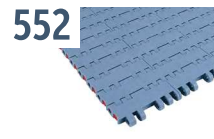

552 FT
Pag 195

552 FT One track Belt
Pag 196

552 FTT
Pag 197

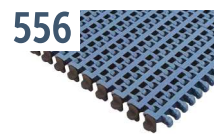

556 FT
Pag 199

556 GT
Pag 200

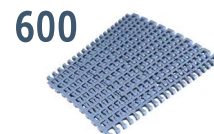

600 Standard
Pag 202

600 Heavy duty
Pag 203

600 Small radius
Pag 204

600 Heavy duty/ Small radius
Pag 205

600 with pusher
Pag 206

1047 Heavy duty guide
Pag 206

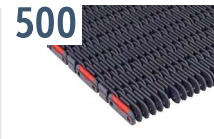

500 RR
Pag 208



389 Combs
Pag 209



260 M FT
Pag 211

260 M FG
Pag 212

260 TAB
Pag 213



261 M FT
Pag 214

261 M TAB
Pag 215

510

Imperial Size

Pitch 8 mm
H= 6 mm



510 FT

510 FT

Tappeto Modulare 510 FT, H=6 M=3"
Modular Belt Series 510 FT, H=6 M=3" / Modulare Mattenkette 510 FT, H=6 M=3"

Imperial Size

CODE STRUCTURE GUIDE			
(Example)			
5331	01	0012	A
Series	*Material	Width	Version

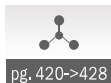

*Material

LFA - Code 01

Low friction Acetal

Max w. load: 3000 N/m
Weight: 5,8 kg/m²
Temp. range: dry -40÷80 °C
wet -40÷65 °C
Pin material: PBT white

MX - Code 03

Performance PBT

Max w. load: 2700 N/m
Weight: 5,5 kg/m²
Temp. range: dry -40÷120 °C
wet -40÷60 °C
Pin material: POM grey

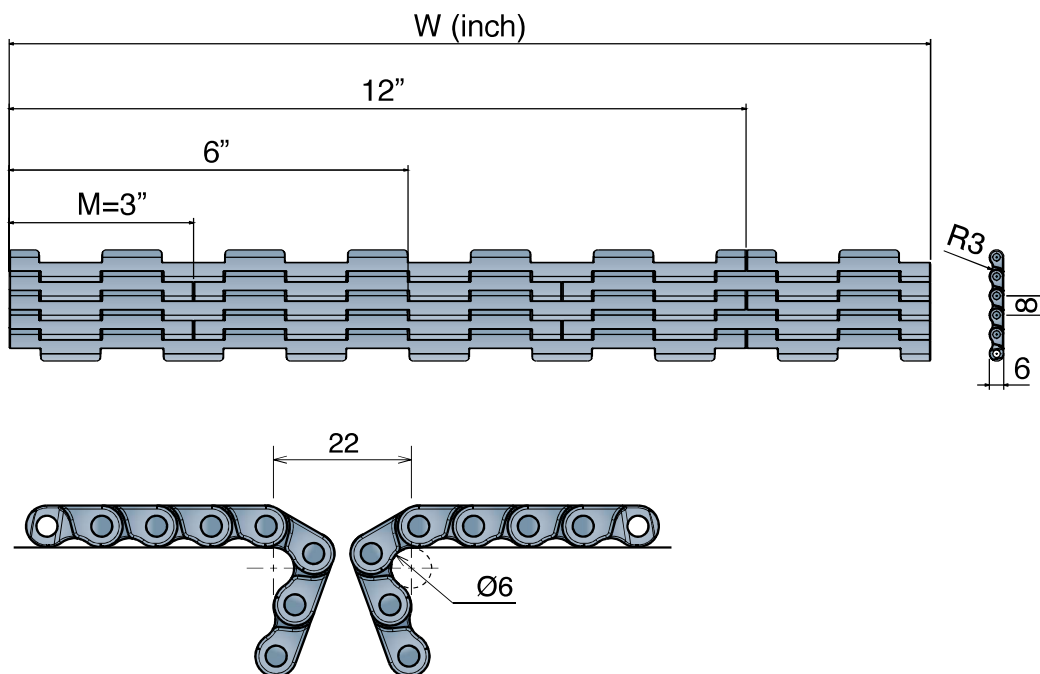

Version A - Standard

Series	Material	Width	Version
5331	*	0003	A
5331	*	0006	A
5331	*	0009	A
5331	*	0012	A
5331	*	0015	A
5331	*	0018	A
5331	*	0021	A
5331	*	0024	A

520/521

Metric Size

Imperial Size

Pitch 12,7 mm
H= 8,7 mm



520 FT
520 FTT
520 FG
520 GT
520 LBP

521 FT
228

520 FT

Tappeto Modulare 520 FT, H=8,7 M=85
 Modular Belt Series 520 FT, H=8,7 M=85 / Modulare Mattenkette 520 FT, H=8,7 M=85

Metric Size

CODE STRUCTURE GUIDE			
(Example)			
5201	03	0340	C
Series	*Material	Width	Version

Backflex radius min.: 10 mm



pg. 220-221

pg. 420->428

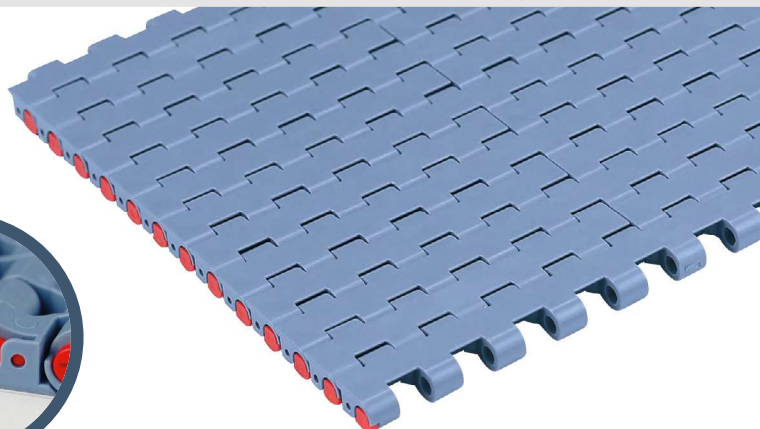
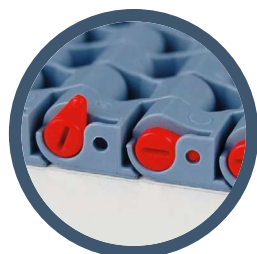

*Material

LFA - Code 01

Low friction Acetal

Max w. load: 21500 N/m
 Weight: 7,8 kg/m²
 Temp. range: dry -40÷80 °C
 wet -40÷65 °C
 Pin material: PBT white

MX - Code 03

Performance PBT

Max w. load: 17500 N/m
 Weight: 7,5 kg/m²
 Temp. range: dry -40÷120 °C
 wet -40÷60 °C
 Pin material: POM grey

MK - Code 08

Super Performance Acetal

Max w. load: 20700 N/m
 Weight: 7,8 kg/m²
 Temp. range: dry -40÷80 °C
 wet -40÷65 °C
 Pin material: PBT white

MPX - Code 25

Lubricated Acetal

Max w. load: 21500 N/m
 Weight: 7,8 kg/m²
 Temp. range: dry -40÷80 °C
 wet -40÷65 °C
 Pin material: PBT white

DKM - Code 16

Aramide Reinforced Acetal

Max w. load: 21500 N/m
 Weight: 7,8 kg/m²
 Temp. range: dry -40÷80 °C
 wet -40÷65 °C
 Pin material: PBT white

MWX - Code 17

Polyamide Composite

Max w. load: 21500 N/m
 Weight: 8,1 kg/m²
 Temp. range: dry -40÷104 °C
 wet NR
 Pin material: PBT white

Version A - Standard

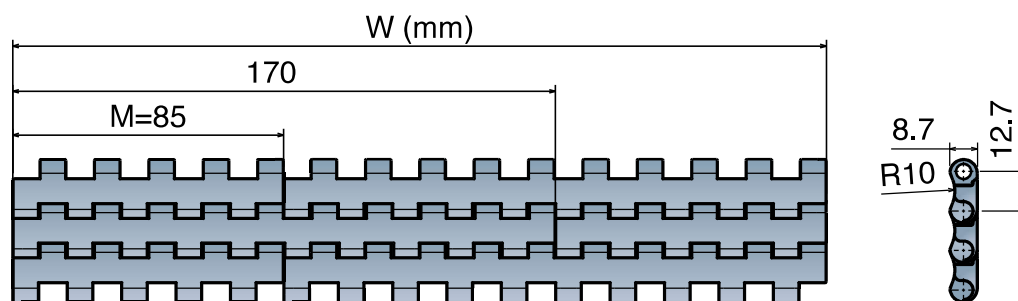

Version B - With 1 Positioner

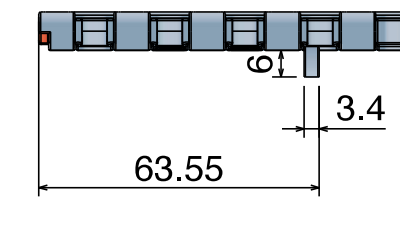

Version C - With 2 Positioner

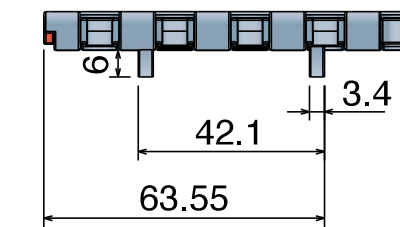

Version A - Standard

Series	Material	Width	Version
5201	*	0085	A
5201	*	0170	A
5201	*	0255	A
5201	*	0340	A
5201	*	0425	A
5201	*	0510	A
5201	*	0595	A
5201	*	0680	A
5201	*	0765	A
5201	*	0850	A
5201	*	0935	A
5201	*	1020	A
5201	*	1105	A
5201	*	1190	A
5201	*	1275	A
5201	*	1360	A
5201	*	1445	A
5201	*	1530	A

Version B - With 1 Positioner

Series	Material	Width	Version
5201	*	0085	B
5201	*	0170	B
5201	*	0255	B
5201	*	0340	B
5201	*	0425	B
5201	*	0510	B
5201	*	0595	B
5201	*	0680	B
5201	*	0765	B
5201	*	0850	B
5201	*	0935	B
5201	*	1020	B
5201	*	1105	B
5201	*	1190	B
5201	*	1275	B
5201	*	1360	B
5201	*	1445	B
5201	*	1530	B

Version C - With 2 Positioners

Series	Material	Width	Version
5201	*	0085	C
5201	*	0170	C
5201	*	0255	C
5201	*	0340	C
5201	*	0425	C
5201	*	0510	C
5201	*	0595	C
5201	*	0680	C
5201	*	0765	C
5201	*	0850	C
5201	*	0935	C
5201	*	1020	C
5201	*	1105	C
5201	*	1190	C
5201	*	1275	C
5201	*	1360	C
5201	*	1445	C
5201	*	1530	C

520 FTT

Tappeto Modulare 520 FT, H=8,7 M=85
Modular Belt Series 520 FT, H=8,7 M=85 / Modulare Mattenkette 520 FT, H=8,7 M=85

Metric Size

CODE STRUCTURE GUIDE			
(Example)			
5206	01	0170	C
Series	*Material	Width	Version

Backflex radius min.: 10 mm



pg. 220-221

pg. 420->428

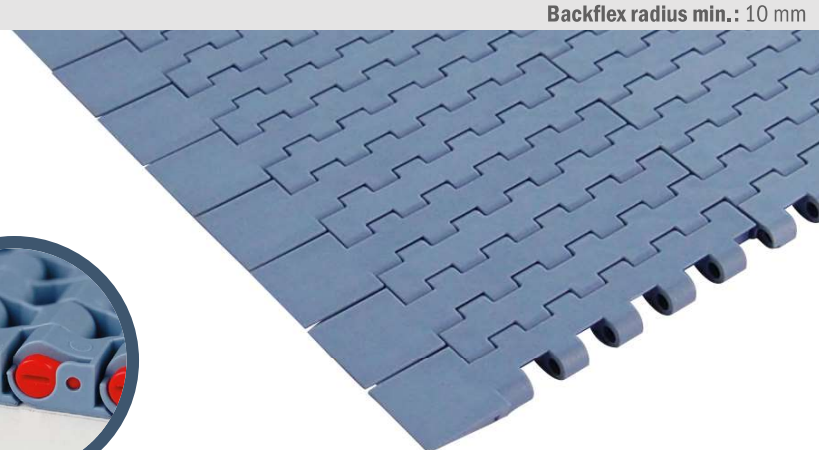
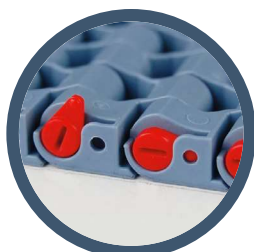

*Material

LFA - Code 01 Low friction Acetal

Max w. load: 21500 N/m
Weight: 7,8 kg/m²
Temp. range: dry -40÷80 °C
wet -40÷65 °C
Pin material: PBT white

MX - Code 03 Performance PBT

Max w. load: 17500 N/m
Weight: 7,5 kg/m²
Temp. range: dry -40÷120 °C
wet -40÷60 °C
Pin material: POM grey

MK - Code 08 Super Performance Acetal

Max w. load: 20700 N/m
Weight: 7,8 kg/m²
Temp. range: dry -40÷80 °C
wet -40÷65 °C
Pin material: PBT white

MPX - Code 25 Lubricated Acetal

Max w. load: 21500 N/m
Weight: 7,8 kg/m²
Temp. range: dry -40÷80 °C
wet -40÷65 °C
Pin material: PBT white

DKM - Code 16 Aramide Reinforced Acetal

Max w. load: 21500 N/m
Weight: 7,8 kg/m²
Temp. range: dry -40÷80 °C
wet -40÷65 °C
Pin material: PBT white

MWX - Code 17 Polyamide Composite

Max w. load: 21500 N/m
Weight: 8,1 kg/m²
Temp. range: dry -40÷104 °C
wet NR
Pin material: PBT white

Version C

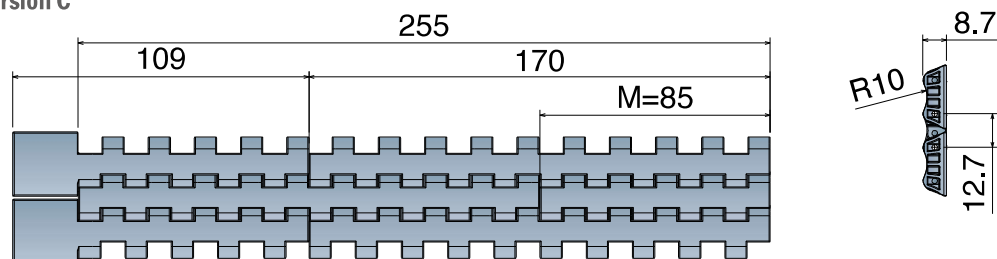

Version CN - Near

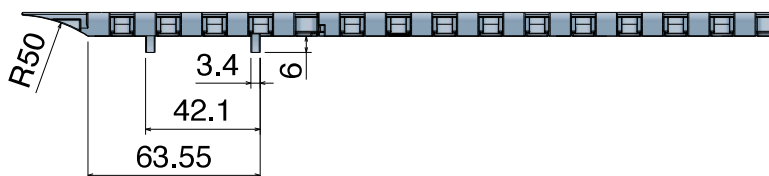

Version C0 - Opposite

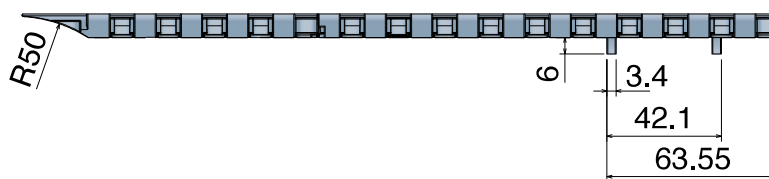

Version C

Series	Material	Width	Version
5206	*	0085	C

Version CN - Near

Series	Material	Width	Version
5206	*	0170	CN
5206	*	0255	CN

Version C0 - Opposite

Series	Material	Width	Version
5206	*	0170	C0
5206	*	0255	C0

520 FG Open Surface 25% Tappeto Modulare 520 FG, H=8,7 M=85 Modular Belt Series 520 FG, H=8,7 M=85 / Modulare Mattenkette 520 FG, H=8,7 M=85

Metric Size

CODE STRUCTURE GUIDE			
(Example)			
5202	01	0765	A
Series	*Material	Width	Version

Backflex radius min.: 10 mm



pg. 220-221

pg. 420->428

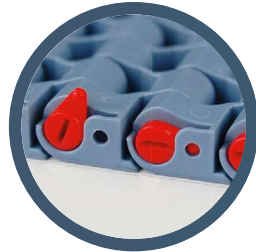
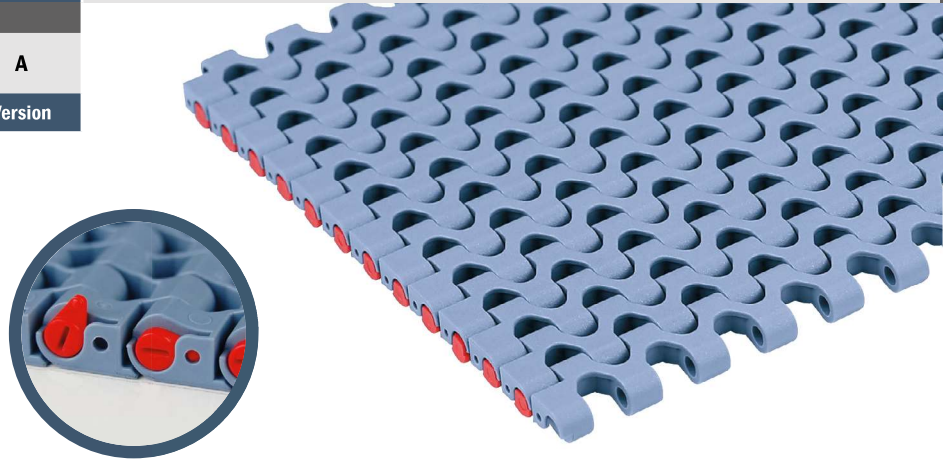

*Material

LFA - Code 01

Low friction Acetal

Max w. load: 21500 N/m
Weight: 7,5 kg/m²
Temp. range: dry -40÷80 °C
wet -40÷65 °C
Pin material: PBT white

MX - Code 03

Performance PBT

Max w. load: 17500 N/m
Weight: 7,2 kg/m²
Temp. range: dry -40÷120 °C
wet -40÷60 °C
Pin material: POM grey

MK - Code 08

Super Performance Acetal

Max w. load: 20700 N/m
Weight: 7,5 kg/m²
Temp. range: dry -40÷80 °C
wet -40÷65 °C
Pin material: PBT white

MPX - Code 25

Lubricated Acetal

Max w. load: 21500 N/m
Weight: 7,5 kg/m²
Temp. range: dry -40÷80 °C
wet -40÷65 °C
Pin material: PBT white

DKM - Code 16

Aramide Reinforced Acetal

Max w. load: 21500 N/m
Weight: 7,5 kg/m²
Temp. range: dry -40÷80 °C
wet -40÷65 °C
Pin material: PBT white

MWX - Code 17

Polyamide Composite

Max w. load: 21500 N/m
Weight: 7,8 kg/m²
Temp. range: dry -40÷104 °C
wet NR
Pin material: PBT white

Version A - Standard

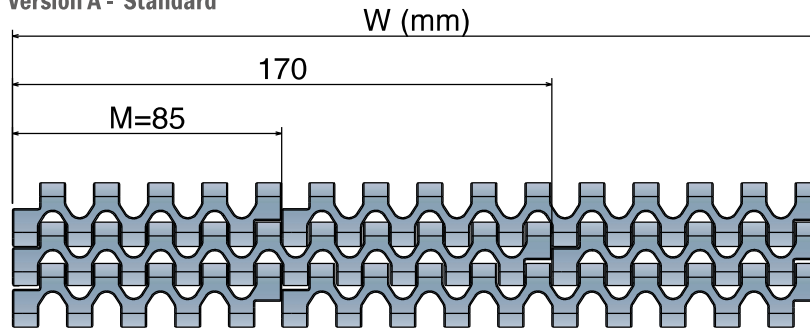

Version B - With 1 Positioner

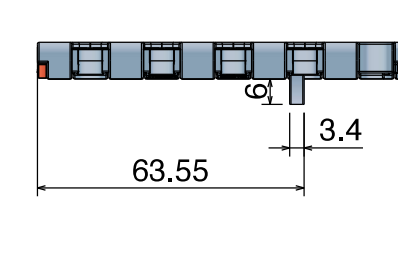

Version C - With 2 Positioner

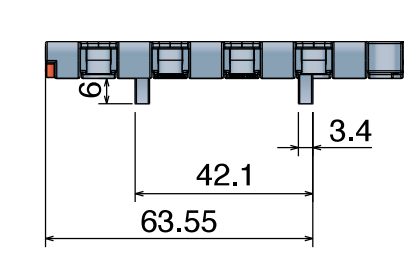

Version A - Standard

Series	Material	Width	Version
5202	*	0085	A
5202	*	0170	A
5202	*	0255	A
5202	*	0340	A
5202	*	0425	A
5202	*	0510	A
5202	*	0595	A
5202	*	0680	A
5202	*	0765	A
5202	*	0850	A
5202	*	0935	A
5202	*	1020	A
5202	*	1105	A
5202	*	1190	A
5202	*	1275	A
5202	*	1360	A
5202	*	1445	A
5202	*	1530	A

Version B - With 1 Positioner

Series	Material	Width	Version
5202	*	0085	B
5202	*	0170	B
5202	*	0255	B
5202	*	0340	B
5202	*	0425	B
5202	*	0510	B
5202	*	0595	B
5202	*	0680	B
5202	*	0765	B
5202	*	0850	B
5202	*	0935	B
5202	*	1020	B
5202	*	1105	B
5202	*	1190	B
5202	*	1275	B
5202	*	1360	B
5202	*	1445	B
5202	*	1530	B

Version C - With 2 Positioners

Series	Material	Width	Version
5202	*	0085	C
5202	*	0170	C
5202	*	0255	C
5202	*	0340	C
5202	*	0425	C
5202	*	0510	C
5202	*	0595	C
5202	*	0680	C
5202	*	0765	C
5202	*	0850	C
5202	*	0935	C
5202	*	1020	C
5202	*	1105	C
5202	*	1190	C
5202	*	1275	C
5202	*	1360	C
5202	*	1445	C
5202	*	1530	C

520 GT

Tappeto Modulare 520 GT, H=8,7 M=85
 Modular Belt Series 520 GT, H=8,7 M=85 / Modulare Mattenkette 520 GT, H=8,7 M=85

Metric Size

CODE STRUCTURE GUIDE			
(Example)			
5203	02	0510	B
Series	*Material	Width	Version

Backflex radius min.: 20 mm



pg. 220-221

pg. 420->428

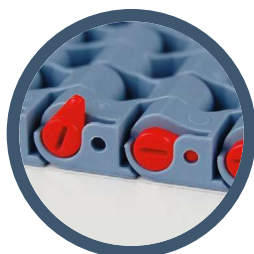

*Material

LFA - Code 01

Low friction Acetal

Max w. load: 21500 N/m
 Weight: 9,0 kg/m²
 Temp. range: dry -40+80 °C
 wet -40+65 °C
 Pin material: PBT white
 Hardness of Grip top Rubber: 75 ShA

PP - Code 02

Polypropylene

Max w. load: 13000 N/m
 Weight: 7,5 kg/m²
 Temp. range: dry 4+80 °C
 wet 4+65 °C
 Pin material: PP blu
 Hardness of Grip top Rubber: 75 ShA

MX - Code 03

Performance PBT

Max w. load: 17500 N/m
 Weight: 9,3 kg/m²
 Temp. range: dry -40+120 °C
 wet -40+60 °C
 Pin material: POM grey
 Hardness of Grip top Rubber: 75 ShA

Version A - Standard

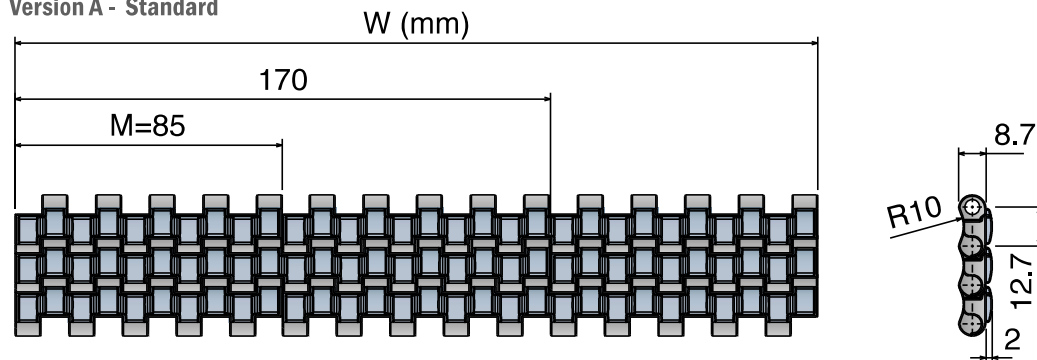

Version B - With 1 Positioner

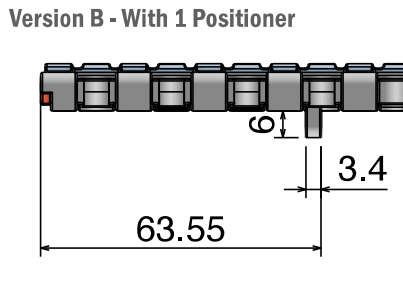

Version C - With 2 Positioner

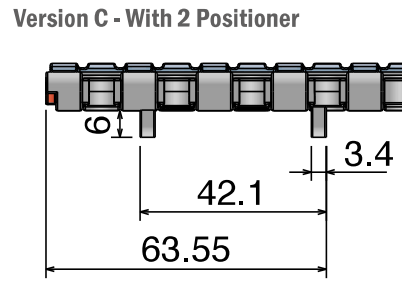

Version A - Standard

Series	Material	Width	Version
5203	*	0085	A
5203	*	0170	A
5203	*	0255	A
5203	*	0340	A
5203	*	0425	A
5203	*	0510	A
5203	*	0595	A
5203	*	0680	A
5203	*	0765	A
5203	*	0850	A
5203	*	0935	A
5203	*	1020	A
5203	*	1105	A
5203	*	1190	A
5203	*	1275	A
5203	*	1360	A
5203	*	1445	A
5203	*	1530	A

Version B - With 1 Positioner

Series	Material	Width	Version
5203	*	0085	B
5203	*	0170	B
5203	*	0255	B
5203	*	0340	B
5203	*	0425	B
5203	*	0510	B
5203	*	0595	B
5203	*	0680	B
5203	*	0765	B
5203	*	0850	B
5203	*	0935	B
5203	*	1020	B
5203	*	1105	B
5203	*	1190	B
5203	*	1275	B
5203	*	1360	B
5203	*	1445	B
5203	*	1530	B

Version C - With 2 Positioners

Series	Material	Width	Version
5203	*	0085	C
5203	*	0170	C
5203	*	0255	C
5203	*	0340	C
5203	*	0425	C
5203	*	0510	C
5203	*	0595	C
5203	*	0680	C
5203	*	0765	C
5203	*	0850	C
5203	*	0935	C
5203	*	1020	C
5203	*	1105	C
5203	*	1190	C
5203	*	1275	C
5203	*	1360	C
5203	*	1445	C
5203	*	1530	C

520 LBP

Tappeto Modulare 520 LBP, H=8,7 M=85
 Modular Belt Series 520 LBP, H=8,7 M=85 / Modulare Mattenkette 520 LBP, H=8,7 M=85

Metric Size

CODE STRUCTURE GUIDE			
(Example)			
5204	01	1530	C
Series	*Material	Width	Version

Backflex radius min.: 65 mm

pg. 220-221

pg. 420->428

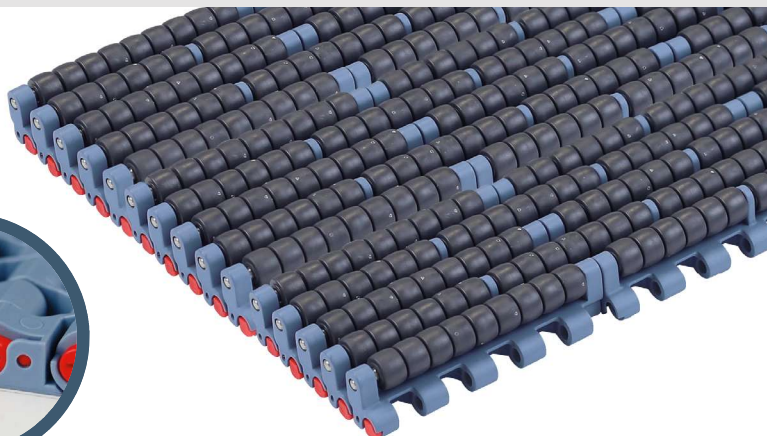
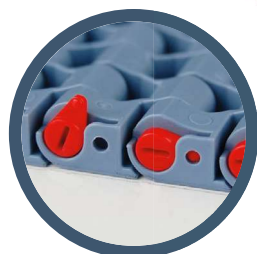

Version A - Standard

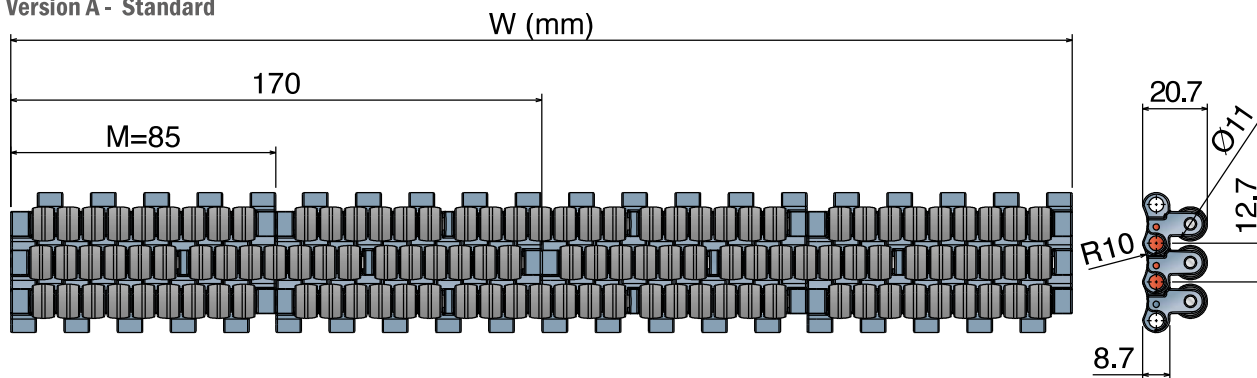

*Material

LFA - Code 01
 Low friction Acetal

Max w. load: 21500 N/m
 Weight: 24,0 kg/m²
 Temp. range: dry -40÷80 °C
 wet 1÷65 °C
 Pin material: PBT white

Version B - With 1 Positioner

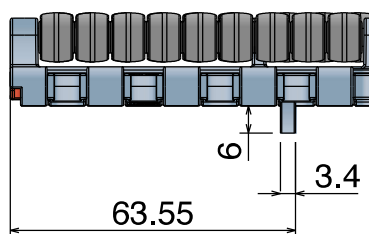

Version C - With 2 Positioner

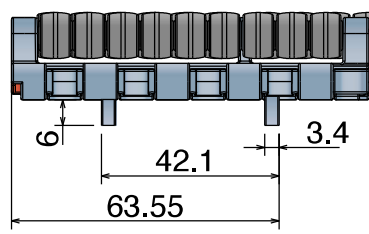

Version A - Standard

Series	Material	Width	Version
5204	*	0085	A
5204	*	0170	A
5204	*	0255	A
5204	*	0340	A
5204	*	0425	A
5204	*	0510	A
5204	*	0595	A
5204	*	0680	A
5204	*	0765	A
5204	*	0850	A
5204	*	0935	A
5204	*	1020	A
5204	*	1105	A
5204	*	1190	A
5204	*	1275	A
5204	*	1360	A
5204	*	1445	A
5204	*	1530	A

Version B - With 1 Positioner

Series	Material	Width	Version
5204	*	0085	B
5204	*	0170	B
5204	*	0255	B
5204	*	0340	B
5204	*	0425	B
5204	*	0510	B
5204	*	0595	B
5204	*	0680	B
5204	*	0765	B
5204	*	0850	B
5204	*	0935	B
5204	*	1020	B
5204	*	1105	B
5204	*	1190	B
5204	*	1275	B
5204	*	1360	B
5204	*	1445	B
5204	*	1530	B

Version C - With 2 Positioners

Series	Material	Width	Version
5204	*	0085	C
5204	*	0170	C
5204	*	0255	C
5204	*	0340	C
5204	*	0425	C
5204	*	0510	C
5204	*	0595	C
5204	*	0680	C
5204	*	0765	C
5204	*	0850	C
5204	*	0935	C
5204	*	1020	C
5204	*	1105	C
5204	*	1190	C
5204	*	1275	C
5204	*	1360	C
5204	*	1445	C
5204	*	1530	C

521 FT

Tappeto Modulare 521 FT, H=8,7 M=7,5"
 Modular Belt Series 521 FT, H=8,7 M=7,5" / Modulare Mattenkette 521 FT, H=8,7 M=7,5"

Imperial Size

CODE STRUCTURE GUIDE			
(Example)			
5311	01	9750	C
Series	*Material	Width	Version

Backflex radius min.: 10 mm



pg. 219

pg. 420->428

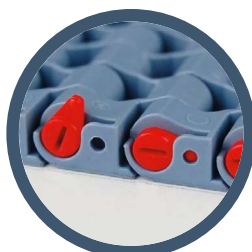

*Material

LFA - Code 01

Low friction Acetal

Max w. load: 21500 N/m
Weight: 8,0 kg/m²
Temp. range: dry -40÷80 °C
 wet -40÷65 °C
Pin material: PBT white

MX - Code 03

Performance PBT

Max w. load: 17500 N/m
Weight: 7,8 kg/m²
Temp. range: dry -40÷120 °C
 wet -40÷60 °C
Pin material: POM grey

MK - Code 08

Super Performance Acetal

Max w. load: 20700 N/m
Weight: 8,0 kg/m²
Temp. range: dry -40÷80 °C
 wet -40÷65 °C
Pin material: PBT white

MPX - Code 25

Lubricated Acetal

Max w. load: 21500 N/m
Weight: 8,0 kg/m²
Temp. range: dry -40÷80 °C
 wet -40÷65 °C
Pin material: PBT white

DKM - Code 16

Aramide Reinforced Acetal

Max w. load: 21500 N/m
Weight: 8,0 kg/m²
Temp. range: dry -40÷80 °C
 wet -40÷65 °C
Pin material: PBT white

MWX - Code 17

Polyamide Composite

Max w. load: 21500 N/m
Weight: 8,3 kg/m²
Temp. range: dry -40÷104 °C
 wet NR
Pin material: PBT white

Version A - Standard

M=7.5"

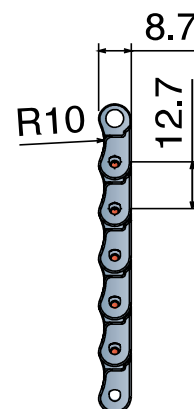
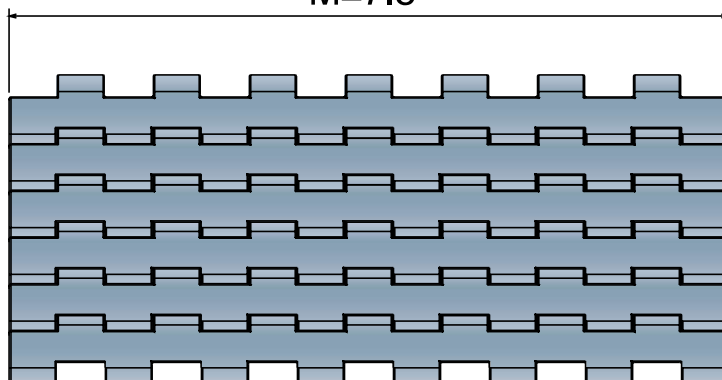

Version B - With 1 Positioner

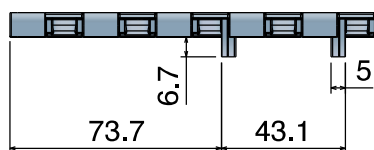

Version A - Standard

Series	Material	Width	Version
5311	*	9750	A

Version C - With 2 Positioners

Series	Material	Width	Version
5311	*	9750	C

228

Piatto di trasferimento
Transfer Plate / Überschubplatte

Used with belt series 520 - 521 - 525 - 530

Transfer plate

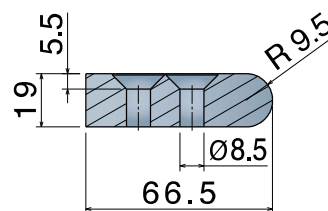
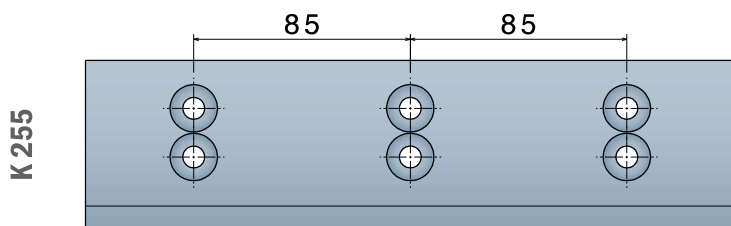
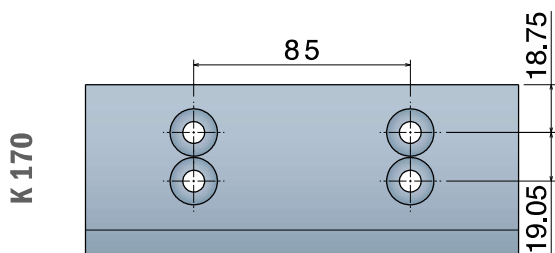
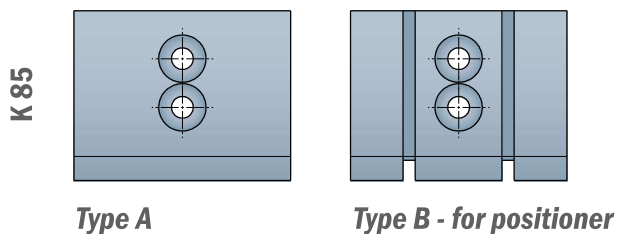

Part	Article-Nr.	K	Type
228	22801	85	A
228	22807	85	B
228	22802	170	A
228	22803	255	A

Available in different widths on request.

Transfer plate with rollers

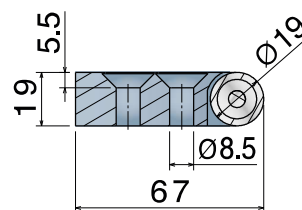
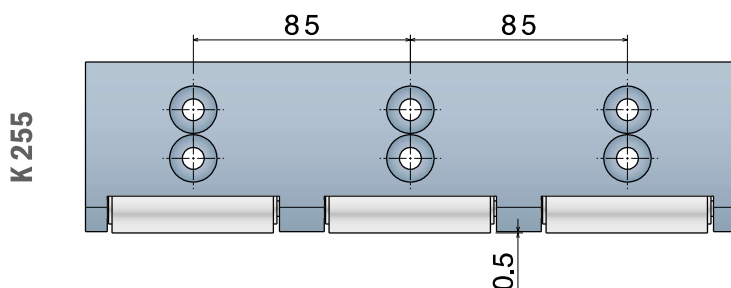
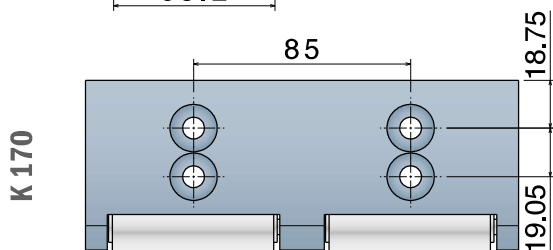
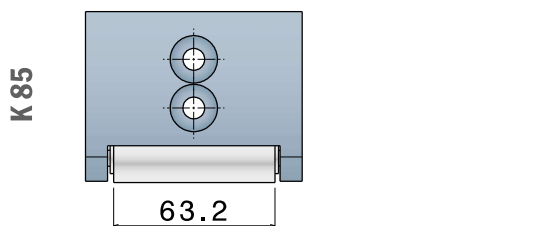

Part	Article-Nr.	K
228	22814	85
228	22815	170
228	22816	255

Available in different widths on request.

228 Piatto di trasferimento Transfer Plate / Übershubplatte

Used with belt series 520 - 521 - 525 - 530

Transfer plate with bearings

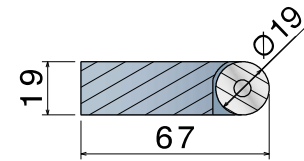
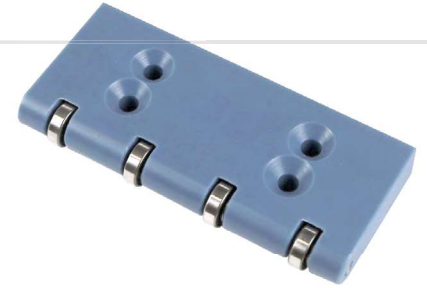
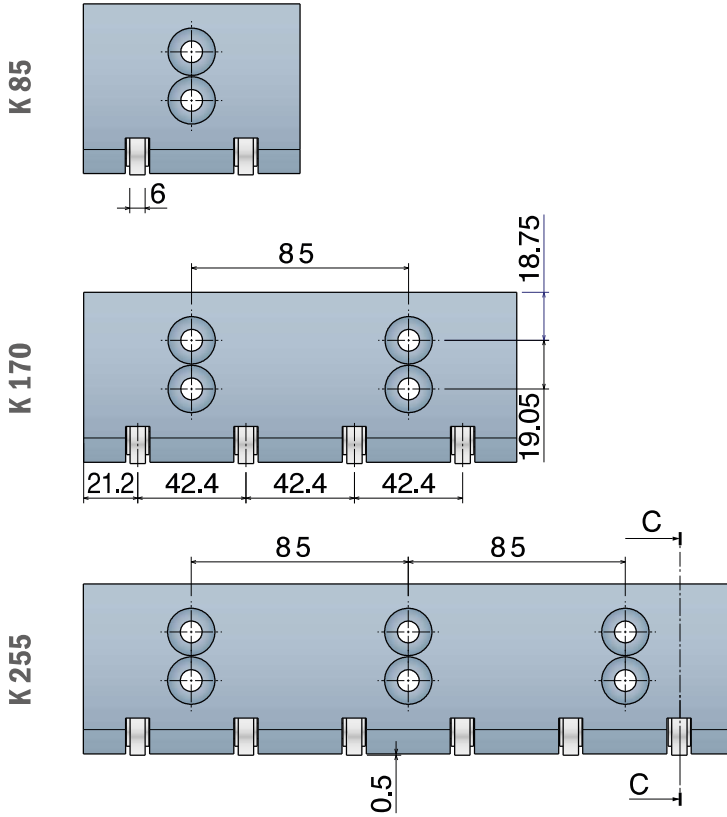

Part	Article-Nr.	K
228	22811	85
228	22812	170
228	22813	255

Available in different widths on request.

INSTALLATION TIPS

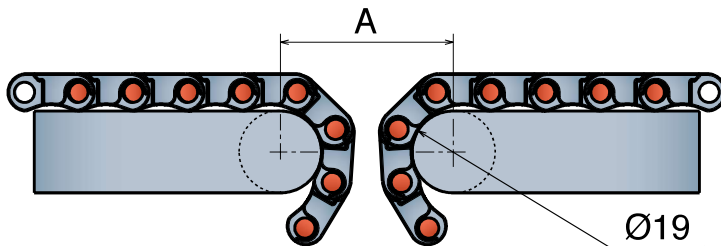

Belt type 1	Belt type 2	A
FT/ FG	FT/ FG	40
FT/ FG	GT	42
FT/ FG	LBP	53
GT	GT	44
GT	LBP	55
LBP	LBP	65



Transfer plate with roller

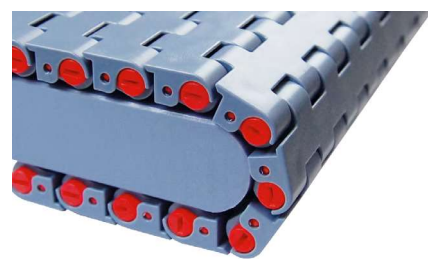

Transfer plate

590 Series

590

Imperial Size

Pitch 19,05 mm
H= 8,7 mm



590 FT
590 FT *One track Belt*
590 FTT

Movex®

590 FT

Tappeto Modulare 590 FT, H=8,7 M=3"
 Modular Belt Series 590 FT, H=8,7 M=3" / Modulare Mattenkette 590 FT, H=8,7 M=3"

Imperial Size

CODE STRUCTURE GUIDE			
(Example)			
5301	01	0009	C
Series	*Material	Width	Version

Backflex radius min.: 25 mm

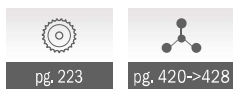

pg. 223

pg. 420->428

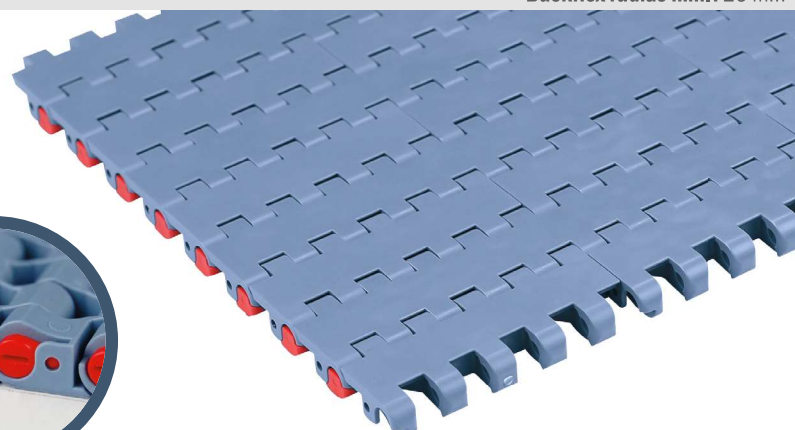
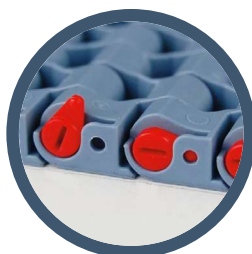

*Material

LFA - Code 01

Low friction Acetal

Max w. load: 30000 N/m
Weight: 7,2 kg/m²
Temp. range: dry -40÷80 °C
 wet -40÷65 °C
Pin material: PBT white

MX - Code 03

Performance PBT

Max w. load: 24000 N/m
Weight: 7,0 kg/m²
Temp. range: dry -40÷120 °C
 wet -40÷60 °C
Pin material: POM grey

MK - Code 08

Super Performance Acetal

Max w. load: 28800 N/m
Weight: 7,2 kg/m²
Temp. range: dry -40÷80 °C
 wet -40÷65 °C
Pin material: PBT white

MPX - Code 25

Lubricated Acetal

Max w. load: 30000 N/m
Weight: 7,2 kg/m²
Temp. range: dry -40÷80 °C
 wet -40÷65 °C
Pin material: PBT white

DKM - Code 16

Aramide Reinforced Acetal

Max w. load: 30000 N/m
Weight: 7,2 kg/m²
Temp. range: dry -40÷80 °C
 wet -40÷65 °C
Pin material: PBT white

MWX - Code 17

Polyamide Composite

Max w. load: 30000 N/m
Weight: 7,5 kg/m²
Temp. range: dry -40÷104 °C
 wet NR
Pin material: PBT white

Version A - Standard

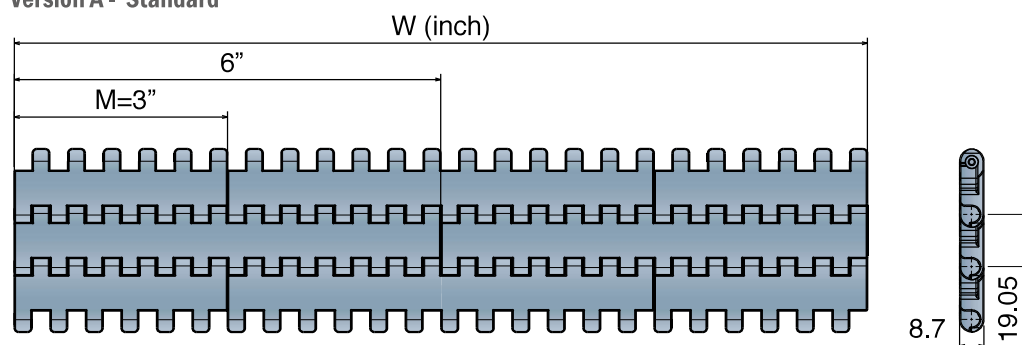

Version C - With 2 Positioner

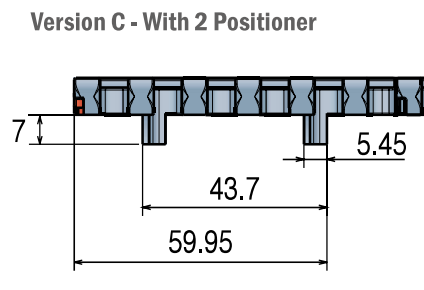

Version A - Standard

Series	Material	Width	Version
5301	*	0003	A
5301	*	0006	A
5301	*	0009	A
5301	*	0012	A
5301	*	0015	A
5301	*	0018	A
5301	*	0021	A
5301	*	0024	A
5301	*	0027	A
5301	*	0030	A
5301	*	0033	A
5301	*	0036	A
5301	*	0039	A
5301	*	0042	A
5301	*	0045	A
5301	*	0048	A
5301	*	0051	A
5301	*	0054	A

Version C - With 2 Positioners

Series	Material	Width	Version
5301	*	0003	C
5301	*	0006	C
5301	*	0009	C
5301	*	0012	C
5301	*	0015	C
5301	*	0018	C
5301	*	0021	C
5301	*	0024	C
5301	*	0027	C
5301	*	0030	C
5301	*	0033	C
5301	*	0036	C
5301	*	0039	C
5301	*	0042	C
5301	*	0045	C
5301	*	0048	C
5301	*	0051	C
5301	*	0054	C

590 FT One track Belt

Tappeto Modulare 590 FT, H=8,7
Modular Belt Series 590 FT, H=8,7 / Modulare Mattenkette 590 FT, H=8,7

Imperial Size

CODE STRUCTURE GUIDE			
(Example)			
5301	03	9325	C
Series	*Material	Width	Version

Backflex radius min.: 25 mm

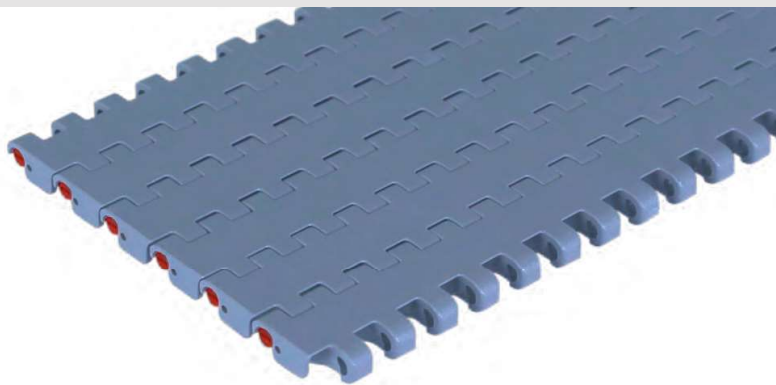

*Material

LFA - Code 01

Low friction Acetal

Max w. load: 30000 N/m
Weight: 7,2 kg/m²
Temp. range: dry -40÷80 °C
wet -40÷65 °C
Pin material: PBT white

MX - Code 03

Performance PBT

Max w. load: 24000 N/m
Weight: 7,0 kg/m²
Temp. range: dry -40÷120 °C
wet -40÷60 °C
Pin material: POM grey

MK - Code 08

Super Performance Acetal

Max w. load: 28800 N/m
Weight: 7,2 kg/m²
Temp. range: dry -40÷80 °C
wet -40÷65 °C
Pin material: PBT white

MPX - Code 25

Lubricated Acetal

Max w. load: 30000 N/m
Weight: 7,2 kg/m²
Temp. range: dry -40÷80 °C
wet -40÷65 °C
Pin material: PBT white

DKM - Code 16

Aramide Reinforced Acetal

Max w. load: 30000 N/m
Weight: 7,2 kg/m²
Temp. range: dry -40÷80 °C
wet -40÷65 °C
Pin material: PBT white

MWX - Code 17

Polyamide Composite

Max w. load: 30000 N/m
Weight: 7,5 kg/m²
Temp. range: dry -40÷104 °C
wet NR
Pin material: PBT white

Version A - Standard

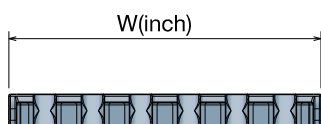

Version C - With 2 Positioner

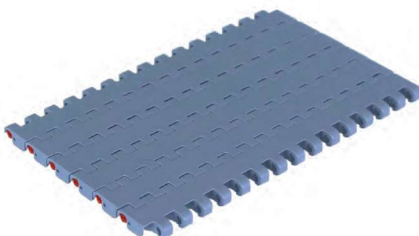
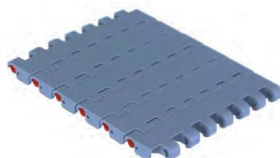
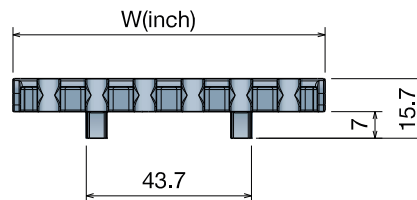

K325 - One track belt

Series	Material	Width	Version
5301	*	9325	A
5301	*	9325	C

K450 - One track belt

Series	Material	Width	Version
5301	*	9450	A
5301	*	9450	C

K750 - One track belt

Series	Material	Width	Version
5301	*	9750	A
5301	*	9750	C

590 FTT

Tappeto Modulare 590 FTT, H=8,7
Modular Belt Series 590 FTT, H=8,7 / Modulare Mattenkette 590 FTT, H=8,7

Imperial Size

CODE STRUCTURE GUIDE			
(Example)			
5306	01	9450	C-R
Series	*Material	Width	Version

Backflex radius min.: 25 mm



pg. 223

pg. 420->428

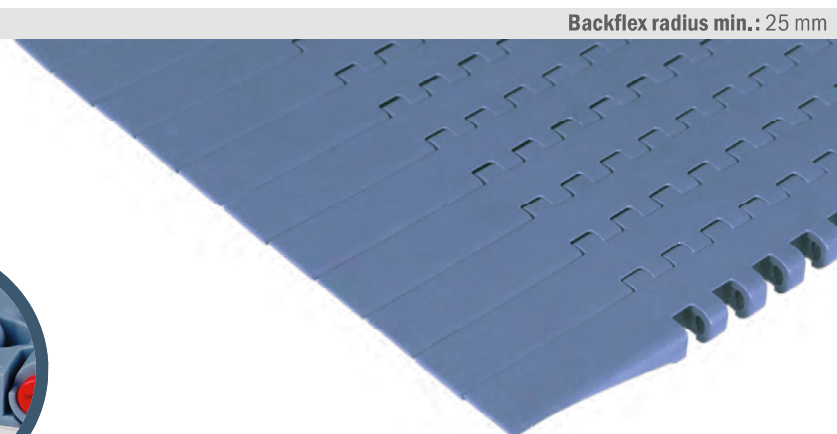
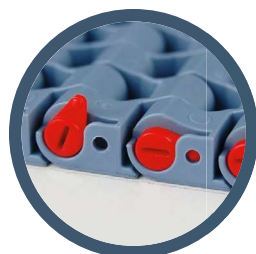

*Material

LFA - Code 01

Low friction Acetal

Max w. load: 30000 N/m
Weight: 7,2 kg/m²
Temp. range: dry -40÷80 °C
wet -40÷65 °C
Pin material: PBT white

MX - Code 03

Performance PBT

Max w. load: 24000 N/m
Weight: 7,0 kg/m²
Temp. range: dry -40÷120 °C
wet -40÷60 °C
Pin material: POM grey

MK - Code 08

Super Performance Acetal

Max w. load: 28800 N/m
Weight: 7,2 kg/m²
Temp. range: dry -40÷80 °C
wet -40÷65 °C
Pin material: PBT white

MPX - Code 25

Lubricated Acetal

Max w. load: 30000 N/m
Weight: 7,2 kg/m²
Temp. range: dry -40÷80 °C
wet -40÷65 °C
Pin material: PBT white

DKM - Code 16

Aramide Reinforced Acetal

Max w. load: 30000 N/m
Weight: 7,2 kg/m²
Temp. range: dry -40÷80 °C
wet -40÷65 °C
Pin material: PBT white

MWX - Code 17

Polyamide Composite

Max w. load: 30000 N/m
Weight: 7,5 kg/m²
Temp. range: dry -40÷104 °C
wet NR
Pin material: PBT white

Version 590 FTT DX

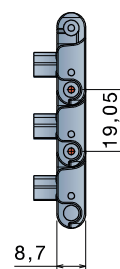
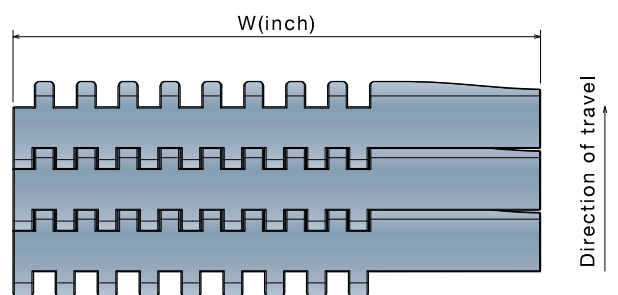
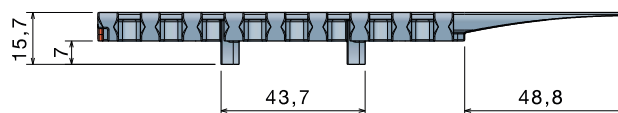

Version 590 FTT SX

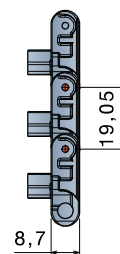
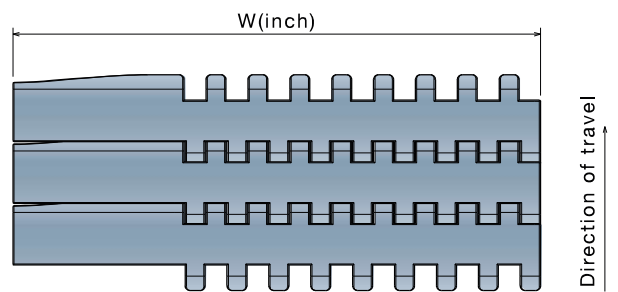
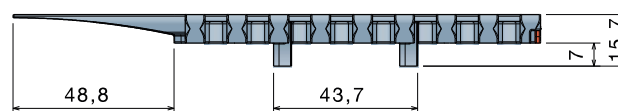

Version 590 FTT DX

Series	Material	Width	Version
5306	*	9450	C-R
5306	*	9750	C-R

Version 590 FTT SX

Series	Material	Width	Version
5306	*	9450	C-L
5306	*	9750	C-L

525

Metric Size

Pitch 15 mm

H= 8,7 mm

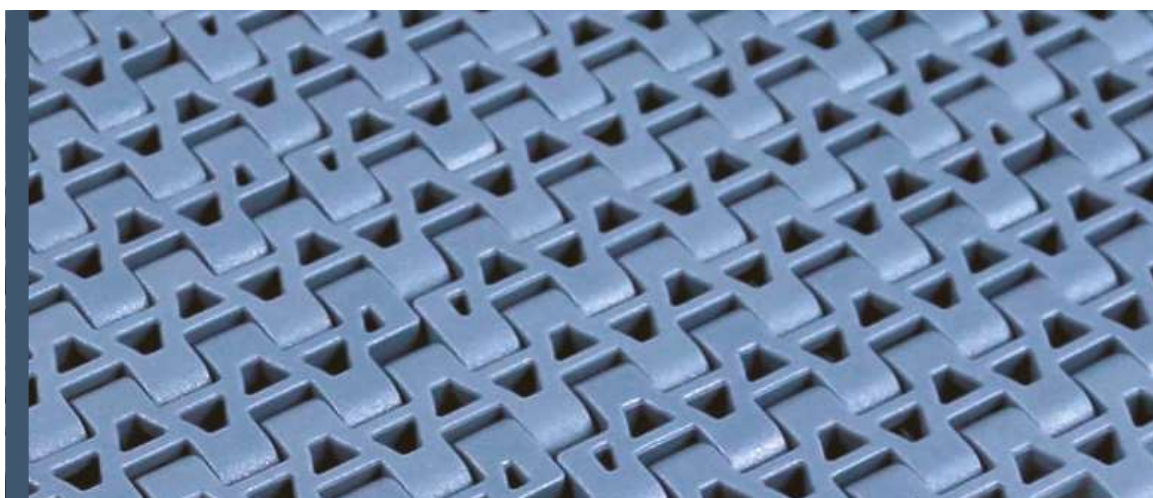

525 FT

525 FTT

525 GT

525 GT *Side indent*

525 HD FT

525 HD FG

525 HD GT

525 HD GT *Side indent*

525 FT

Tappeto Modulare 525 FT, H=8,7 M=85
Modular Belt Series 525 FT, H=8,7 M=85 / Modulare Mattenkette 525 FT, H=8,7 M=85

Metric Size

CODE STRUCTURE GUIDE			
(Example)			
5251	03	0340	C
Series	*Material	Width	Version

Backflex radius min.: 25 mm



pg. 222

pg. 420->428

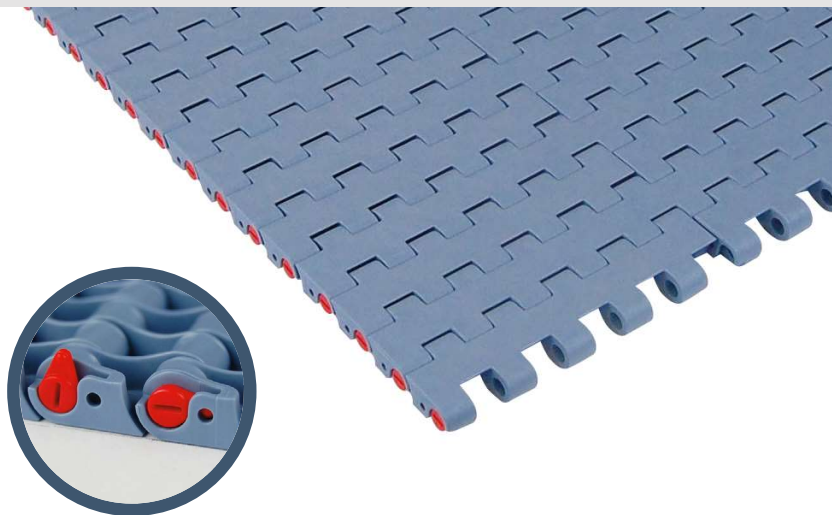

*Material

LFA - Code 01

Low friction Acetal

Max w. load: 21500 N/m
Weight: 7,8 kg/m²
Temp. range: dry -40÷80 °C
wet -40÷65 °C
Pin material: PBT white

MX - Code 03

Performance PBT

Max w. load: 17500 N/m
Weight: 7,5 kg/m²
Temp. range: dry -40÷120 °C
wet -40÷60 °C
Pin material: POM grey

MK - Code 08

Super Performance Acetal

Max w. load: 20700 N/m
Weight: 7,8 kg/m²
Temp. range: dry -40÷80 °C
wet -40÷65 °C
Pin material: PBT white

MPX - Code 25

Lubricated Acetal

Max w. load: 21500 N/m
Weight: 7,8 kg/m²
Temp. range: dry -40÷80 °C
wet -40÷65 °C
Pin material: PBT white

DKM - Code 16

Aramide Reinforced Acetal

Max w. load: 21500 N/m
Weight: 7,8 kg/m²
Temp. range: dry -40÷80 °C
wet -40÷65 °C
Pin material: PBT white

MWX - Code 17

Polyamide Composite

Max w. load: 21500 N/m
Weight: 8,1 kg/m²
Temp. range: dry -40÷104 °C
wet NR
Pin material: PBT white

Version A - Standard

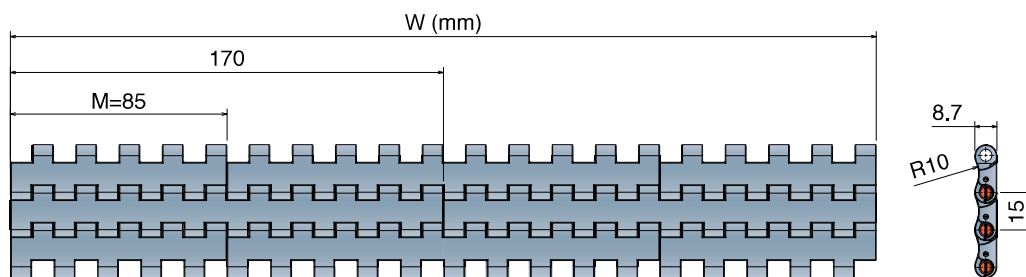

Version B - With 1 Positioner

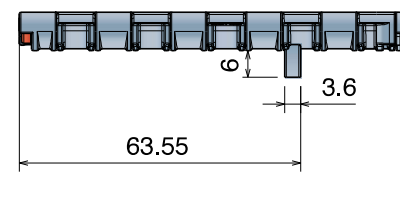

Version C - With 2 Positioners

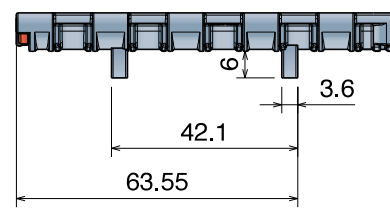

Version A - Standard

Series	Material	Width	Version
5251	*	0085	A
5251	*	0170	A
5251	*	0255	A
5251	*	0340	A
5251	*	0425	A
5251	*	0510	A
5251	*	0595	A
5251	*	0680	A
5251	*	0765	A
5251	*	0850	A
5251	*	0935	A
5251	*	1020	A
5251	*	1105	A
5251	*	1190	A
5251	*	1275	A
5251	*	1360	A
5251	*	1445	A
5251	*	1530	A

Version B - With 1 Positioner

Series	Material	Width	Version
5251	*	0085	B
5251	*	0170	B
5251	*	0255	B
5251	*	0340	B
5251	*	0425	B
5251	*	0510	B
5251	*	0595	B
5251	*	0680	B
5251	*	0765	B
5251	*	0850	B
5251	*	0935	B
5251	*	1020	B
5251	*	1105	B
5251	*	1190	B
5251	*	1275	B
5251	*	1360	B
5251	*	1445	B
5251	*	1530	B

Version C - With 2 Positioners

Series	Material	Width	Version
5251	*	0085	C
5251	*	0170	C
5251	*	0255	C
5251	*	0340	C
5251	*	0425	C
5251	*	0510	C
5251	*	0595	C
5251	*	0680	C
5251	*	0765	C
5251	*	0850	C
5251	*	0935	C
5251	*	1020	C
5251	*	1105	C
5251	*	1190	C
5251	*	1275	C
5251	*	1360	C
5251	*	1445	C
5251	*	1530	C

525 FTT

Tappeto Modulare 525 FTT, H=8,7 M=85

Modular Belt Series 525 FTT, H=8,7 M=85 / Modulare Mattenkette 525 FTT, H=8,7 M=85

CODE STRUCTURE GUIDE			
(Example)			
5256	03	0085	CN
Series	*Material	Width	Version

Backflex radius min.: 25 mm

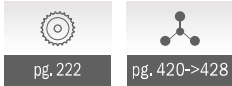

pg. 222

pg. 420->428

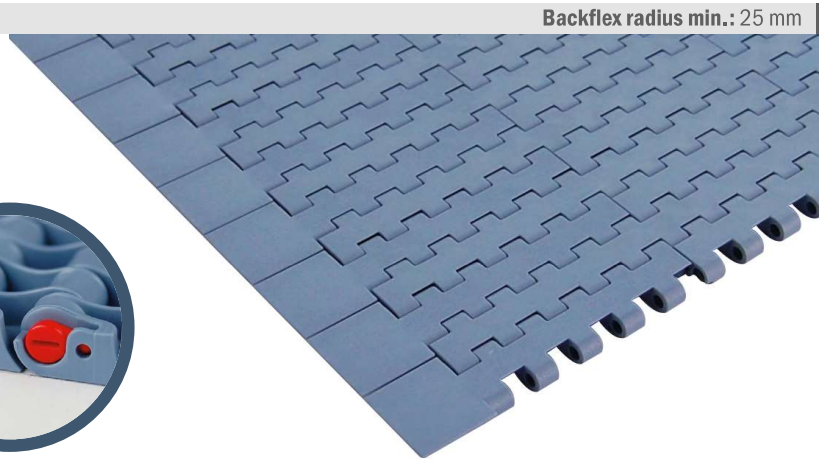

*Material

LFA - Code 01

Low friction Acetal

Max w. load: 21500 N/m
 Weight: 7,8 kg/m²
 Temp. range: dry -40÷80 °C
 wet -40÷65 °C
 Pin material: PBT white

MX - Code 03

Performance PBT

Max w. load: 17500 N/m
 Weight: 7,5 kg/m²
 Temp. range: dry -40÷120 °C
 wet -40÷60 °C
 Pin material: POM grey

MK - Code 08

Super Performance Acetal

Max w. load: 20700 N/m
 Weight: 7,8 kg/m²
 Temp. range: dry -40÷80 °C
 wet -40÷65 °C
 Pin material: PBT white

MPX - Code 25

Lubricated Acetal

Max w. load: 21500 N/m
 Weight: 7,8 kg/m²
 Temp. range: dry -40÷80 °C
 wet -40÷65 °C
 Pin material: PBT white

DKM - Code 16

Aramide Reinforced Acetal

Max w. load: 21500 N/m
 Weight: 7,8 kg/m²
 Temp. range: dry -40÷80 °C
 wet -40÷65 °C
 Pin material: PBT white

MWX - Code 17

Polyamide Composite

Max w. load: 21500 N/m
 Weight: 8,1 kg/m²
 Temp. range: dry -40÷104 °C
 wet NR
 Pin material: PBT white

Version C

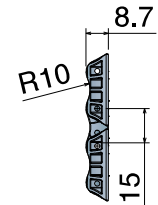
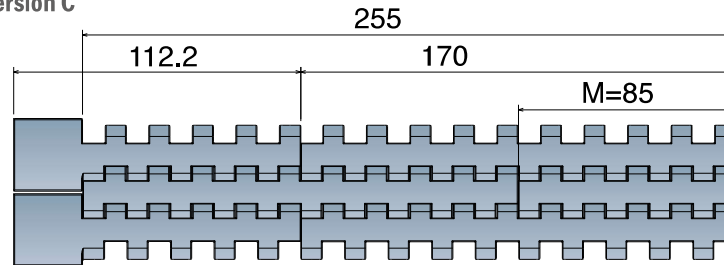

Version CN - Near



Version C0 - Opposite

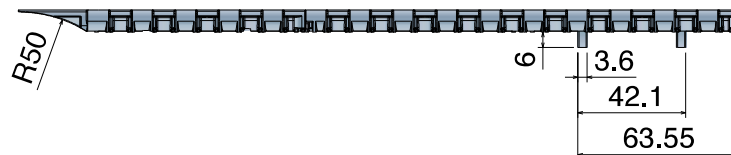

Version C

Series	Material	Width	Version
5226	*	0085	C

Version CN - Near

Series	Material	Width	Version
5226	*	0170	CN
5226	*	0255	CN

Version C0 - Opposite

Series	Material	Width	Version
5226	*	0170	C0
5226	*	0255	C0



FT + Rib

SPECIAL APPLICATION IN PALLETIZER

ADD ON CODE:

- XR3 (RIB every 3 links)
- XR5 (RIB every 5 links)

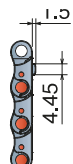
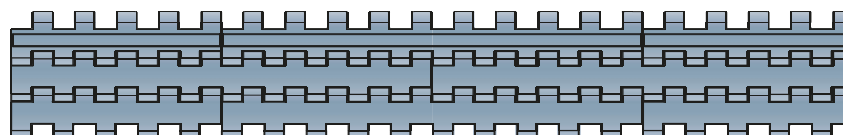

525 GT

Tappeto Modulare 525 GT, H=8,7 M=85
 Modular Belt Series 525 GT, H=8,7 M=85 / Modulare Mattenkette 525 GT, H=8,7 M=85

Metric Size

CODE STRUCTURE GUIDE			
(Example)			
5253	01	0765	A
Series	*Material	Width	Version

Backflex radius min.: 30 mm



pg. 222

pg. 420->428

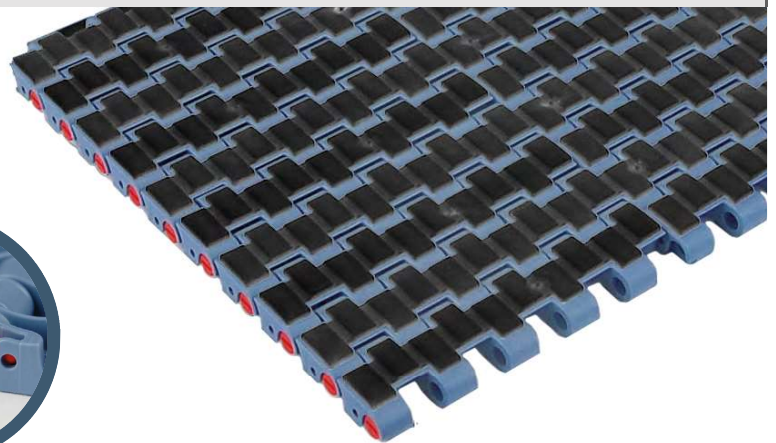
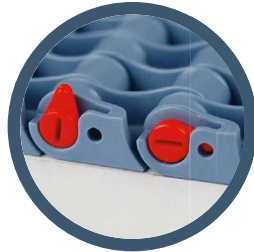

Version A - Standard

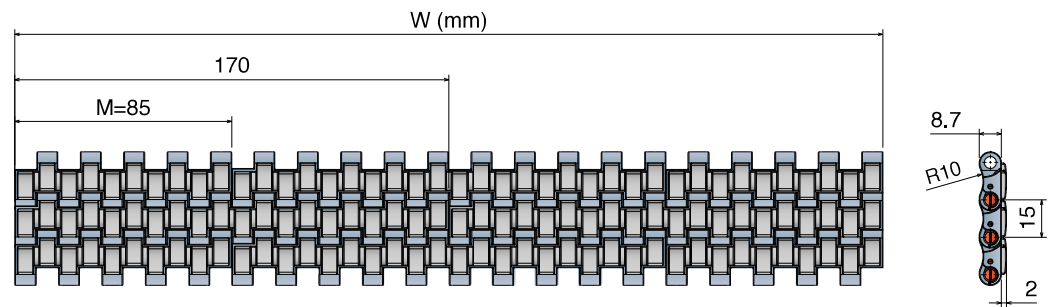

Version B - With 1 Positioner

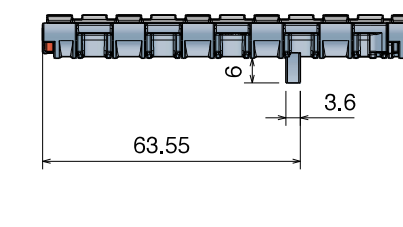

Version C - With 2 Positioners

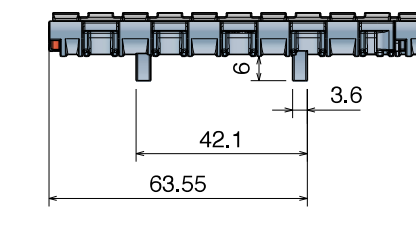

*Material

LFA - Code 01

Low friction Acetal

Max w. load: 21500 N/m
Weight: 7,8 kg/m²
Temp. range: dry -40+80 °C
 wet -40+65 °C
Pin material: PBT white
Hardness of
Grip top Rubber: 75 Sha

PP - Code 02

Polypropylene

Max w. load: 13000 N/m
Weight: 7,5 kg/m²
Temp. range: dry 4+80 °C
 wet 4+65 °C
Pin material: PP blu
Hardness of
Grip top Rubber: 75 Sha

MX - Code 03

Performance PBT

Max w. load: 17500 N/m
Weight: 7,8 kg/m²
Temp. range: dry -40+120 °C
 wet -40+60 °C
Pin material: POM grey
Hardness of
Grip top Rubber: 75 Sha

Version A - Standard

Series	Material	Width	Version
5253	*	0085	A
5253	*	0170	A
5253	*	0255	A
5253	*	0340	A
5253	*	0425	A
5253	*	0510	A
5253	*	0595	A
5253	*	0680	A
5253	*	0765	A
5253	*	0850	A
5253	*	0935	A
5253	*	1020	A
5253	*	1105	A
5253	*	1190	A
5253	*	1275	A
5253	*	1360	A
5253	*	1445	A
5253	*	1530	A

Version B - With 1 Positioner

Series	Material	Width	Version
5253	*	0085	B
5253	*	0170	B
5253	*	0255	B
5253	*	0340	B
5253	*	0425	B
5253	*	0510	B
5253	*	0595	B
5253	*	0680	B
5253	*	0765	B
5253	*	0850	B
5253	*	0935	B
5253	*	1020	B
5253	*	1105	B
5253	*	1190	B
5253	*	1275	B
5253	*	1360	B
5253	*	1445	B
5253	*	1530	B

Version C - With 2 Positioners

Series	Material	Width	Version
5253	*	0085	C
5253	*	0170	C
5253	*	0255	C
5253	*	0340	C
5253	*	0425	C
5253	*	0510	C
5253	*	0595	C
5253	*	0680	C
5253	*	0765	C
5253	*	0850	C
5253	*	0935	C
5253	*	1020	C
5253	*	1105	C
5253	*	1190	C
5253	*	1275	C
5253	*	1360	C
5253	*	1445	C
5253	*	1530	C

525 GT Side indent

Tappeto Modulare 525 GT, H=8,7 M=85
 Modular Belt Series 525 GT, H=8,7 M=85 / Modulare Mattenkette 525 GT, H=8,7 M=85

Metric Size

CODE STRUCTURE GUIDE			
(Example)			
5255	03	0340	C
Series	*Material	Width	Version

Backflex radius min.: 30 mm

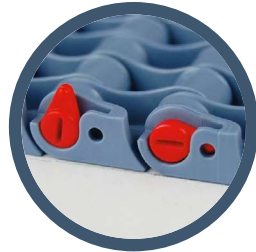
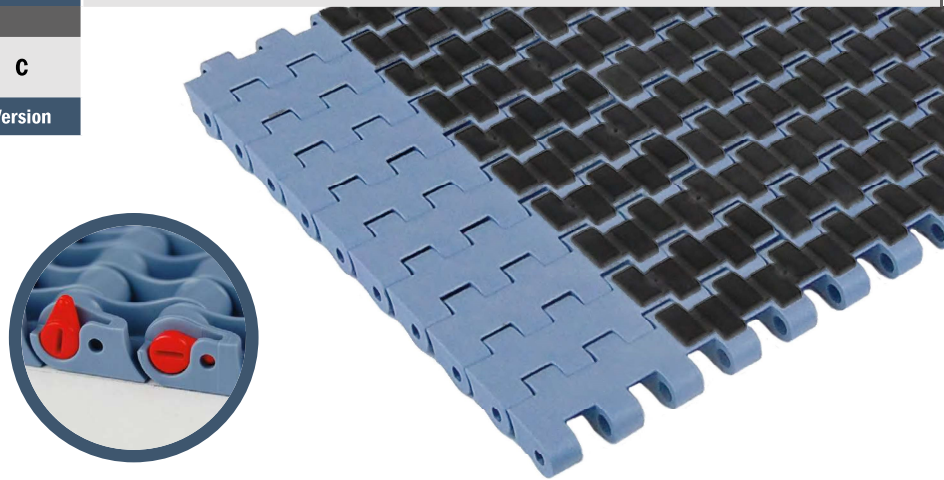
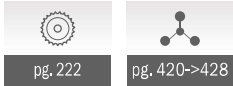

***Material**

LFA - Code 01

Low friction Acetal

Max w. load: 21500 N/m
 Weight: 7,8 kg/m²
 Temp. range: dry -40÷80 °C
 wet -40÷65 °C
 Pin material: PBT white
 Hardness of
 Grip top Rubber: 75 Sha

PP - Code 02

Polypropylene

Max w. load: 13000 N/m
 Weight: 7,5 kg/m²
 Temp. range: dry 4÷80 °C
 wet 4÷65 °C
 Pin material: PP blu
 Hardness of
 Grip top Rubber: 75 Sha

MX - Code 03

Performance PBT

Max w. load: 17500 N/m
 Weight: 7,8 kg/m²
 Temp. range: dry -40÷120 °C
 wet -40÷60 °C
 Pin material: POM grey
 Hardness of
 Grip top Rubber: 75 Sha

Version A - Standard

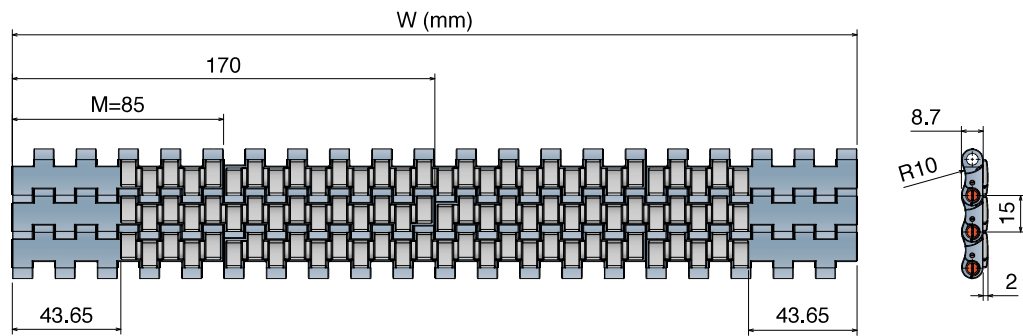

Version B - With 1 Positioner

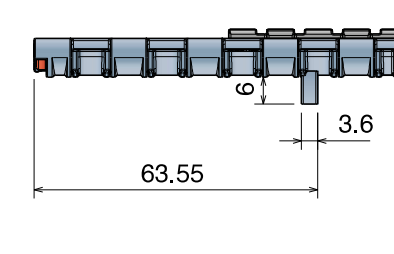

Version C - With 2 Positioner

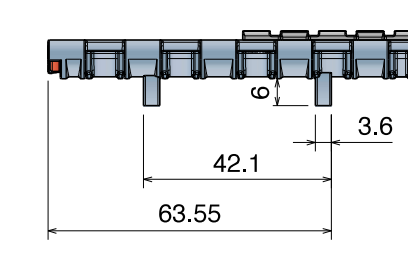

Version A - Standard

Series	Material	Width	Version
5255	*	0255	A
5255	*	0340	A
5255	*	0425	A
5255	*	0510	A
5255	*	0595	A
5255	*	0680	A
5255	*	0765	A
5255	*	0850	A
5255	*	0935	A
5255	*	1020	A
5255	*	1105	A
5255	*	1190	A
5255	*	1275	A
5255	*	1360	A
5255	*	1445	A
5255	*	1530	A

Version B - With 1 Positioner

Series	Material	Width	Version
5255	*	0255	B
5255	*	0340	B
5255	*	0425	B
5255	*	0510	B
5255	*	0595	B
5255	*	0680	B
5255	*	0765	B
5255	*	0850	B
5255	*	0935	B
5255	*	1020	B
5255	*	1105	B
5255	*	1190	B
5255	*	1275	B
5255	*	1360	B
5255	*	1445	B
5255	*	1530	B

Version C - With 2 Positioners

Series	Material	Width	Version
5255	*	0255	C
5255	*	0340	C
5255	*	0425	C
5255	*	0510	C
5255	*	0595	C
5255	*	0680	C
5255	*	0765	C
5255	*	0850	C
5255	*	0935	C
5255	*	1020	C
5255	*	1105	C
5255	*	1190	C
5255	*	1275	C
5255	*	1360	C
5255	*	1445	C
5255	*	1530	C

525 HD FT Tappeto Modulare 525 HD, H=8,7 M=85

Modular Belt Series 525 HD, H=8,7 M=85 / Modulare Mattenkette 525 HD, H=8,7 M=85

Metric Size

CODE STRUCTURE GUIDE			
(Example)			
5261	03	0340	C
Series	*Material	Width	Version

Backflex radius min.: 25 mm

New

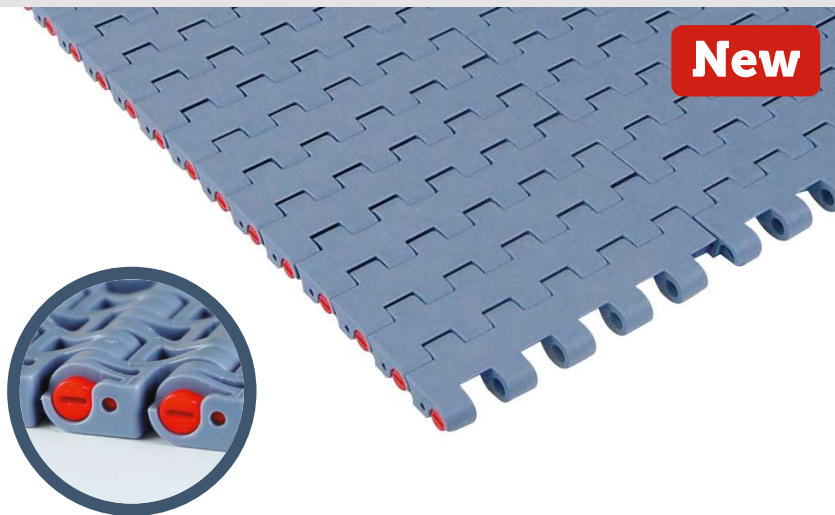

*Material

LFA - Code 01 Low friction Acetal

Max w. load: 25500 N/m
Weight: 9,0 kg/m²
Temp. range: dry -40÷80 °C
wet -40÷65 °C
Pin material: PBT white

MX - Code 03 Performance PBT

Max w. load: 20500 N/m
Weight: 8,7 kg/m²
Temp. range: dry -40÷120 °C
wet -40÷60 °C
Pin material: POM grey

MK - Code 08 Super Performance Acetal

Max w. load: 24500 N/m
Weight: 9,0 kg/m²
Temp. range: dry -40÷80 °C
wet -40÷65 °C
Pin material: PBT white

MPX - Code 25 Lubricated Acetal

Max w. load: 25500 N/m
Weight: 9,0 kg/m²
Temp. range: dry -40÷80 °C
wet -40÷65 °C
Pin material: PBT white

DKM - Code 16 Aramide Reinforced Acetal

Max w. load: 25500 N/m
Weight: 9,0 kg/m²
Temp. range: dry -40÷80 °C
wet -40÷65 °C
Pin material: PBT white

MWX - Code 17 Polyamide Composite

Max w. load: 25500 N/m
Weight: 9,3 kg/m²
Temp. range: dry -40÷104 °C
wet NR
Pin material: PBT white

Version A - Standard

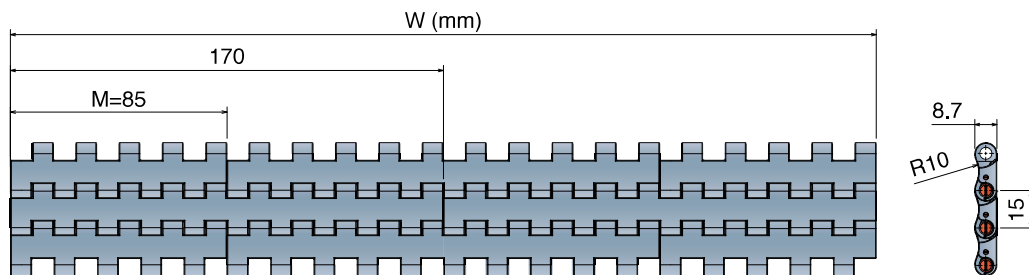

Version B - With 1 Positioner

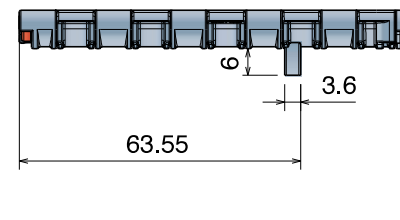

Version C - With 2 Positioners

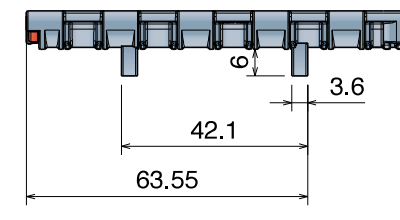

Version A - Standard

Series	Material	Width	Version
5261	*	0085	A
5261	*	0170	A
5261	*	0255	A
5261	*	0340	A
5261	*	0425	A
5261	*	0510	A
5261	*	0595	A
5261	*	0680	A
5261	*	0765	A
5261	*	0850	A
5261	*	0935	A
5261	*	1020	A
5261	*	1105	A
5261	*	1190	A
5261	*	1275	A
5261	*	1360	A
5261	*	1445	A
5261	*	1530	A

Version B - With 1 Positioner

Series	Material	Width	Version
5261	*	0085	B
5261	*	0170	B
5261	*	0255	B
5261	*	0340	B
5261	*	0425	B
5261	*	0510	B
5261	*	0595	B
5261	*	0680	B
5261	*	0765	B
5261	*	0850	B
5261	*	0935	B
5261	*	1020	B
5261	*	1105	B
5261	*	1190	B
5261	*	1275	B
5261	*	1360	B
5261	*	1445	B
5261	*	1530	B

Version C - With 2 Positioners

Series	Material	Width	Version
5261	*	0085	C
5261	*	0170	C
5261	*	0255	C
5261	*	0340	C
5261	*	0425	C
5261	*	0510	C
5261	*	0595	C
5261	*	0680	C
5261	*	0765	C
5261	*	0850	C
5261	*	0935	C
5261	*	1020	C
5261	*	1105	C
5261	*	1190	C
5261	*	1275	C
5261	*	1360	C
5261	*	1445	C
5261	*	1530	C

525 HD FG

Tappeto Modulare 525 HD Flush grid, H=8,7 M=85
 Modular Belt Series 525 HD Flush grid, H=8,7 M=85 / Modulare Mattenkette 525 HD Flush grid, H=8,7 M=85

Metric Size

CODE STRUCTURE GUIDE			
(Example)			
5262	03	0340	C
Series	*Material	Width	Version

Backflex radius min.: 25 mm

New

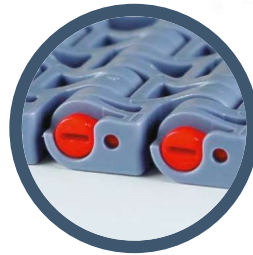
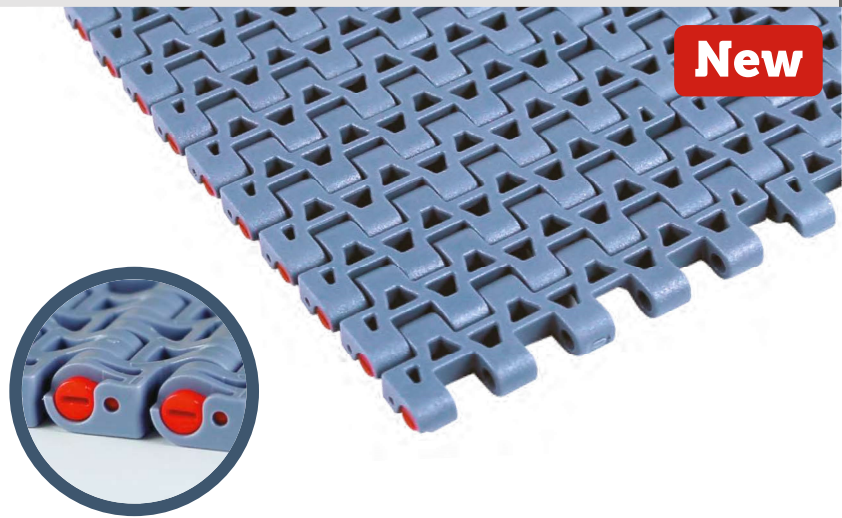

*Material

LFA - Code 01

Low friction Acetal

Max w. load: 25500 N/m
 Weight: 8,1 kg/m²
 Temp. range: dry -40÷80 °C
 wet -40÷65 °C
 Pin material: PBT white

MX - Code 03

Performance PBT

Max w. load: 20500 N/m
 Weight: 7,8 kg/m²
 Temp. range: dry -40÷120 °C
 wet -40÷60 °C
 Pin material: POM grey

MK - Code 08

Super Performance Acetal

Max w. load: 24500 N/m
 Weight: 8,1 kg/m²
 Temp. range: dry -40÷80 °C
 wet -40÷65 °C
 Pin material: PBT white

MPX - Code 25

Lubricated Acetal

Max w. load: 25500 N/m
 Weight: 8,1 kg/m²
 Temp. range: dry -40÷80 °C
 wet -40÷65 °C
 Pin material: PBT white

DKM - Code 16

Aramide Reinforced Acetal

Max w. load: 25500 N/m
 Weight: 8,1 kg/m²
 Temp. range: dry -40÷80 °C
 wet -40÷65 °C
 Pin material: PBT white

MWX - Code 17

Polyamide Composite

Max w. load: 25500 N/m
 Weight: 8,4 kg/m²
 Temp. range: dry -40÷104 °C
 wet NR
 Pin material: PBT white

Version A - Standard

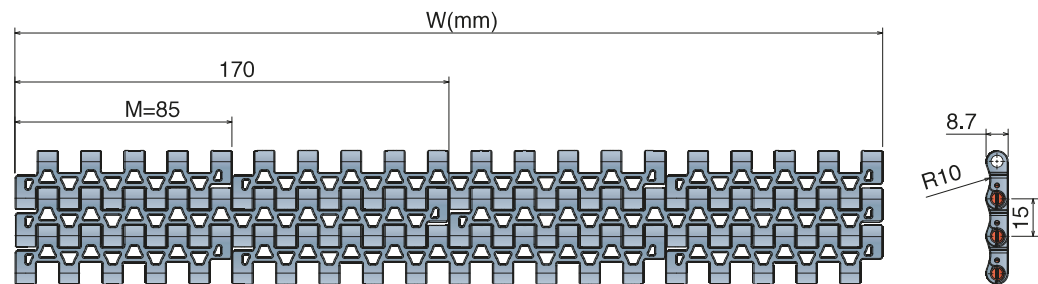

Version B - With 1 Positioner

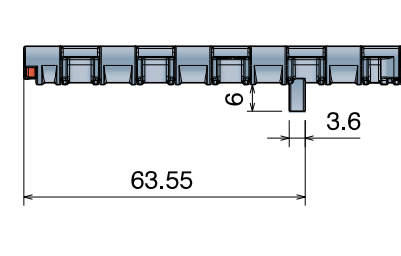

Version C - With 2 Positioners

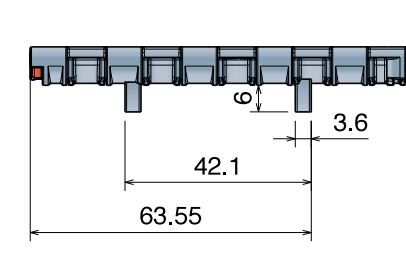

Version A - Standard

Series	Material	Width	Version
5262	*	0085	A
5262	*	0170	A
5262	*	0255	A
5262	*	0340	A
5262	*	0425	A
5262	*	0510	A
5262	*	0595	A
5262	*	0680	A
5262	*	0765	A
5262	*	0850	A
5262	*	0935	A
5262	*	1020	A
5262	*	1105	A
5262	*	1190	A
5262	*	1275	A
5262	*	1360	A
5262	*	1445	A
5262	*	1530	A

Version B - With 1 Positioner

Series	Material	Width	Version
5262	*	0085	B
5262	*	0170	B
5262	*	0255	B
5262	*	0340	B
5262	*	0425	B
5262	*	0510	B
5262	*	0595	B
5262	*	0680	B
5262	*	0765	B
5262	*	0850	B
5262	*	0935	B
5262	*	1020	B
5262	*	1105	B
5262	*	1190	B
5262	*	1275	B
5262	*	1360	B
5262	*	1445	B
5262	*	1530	B

Version C - With 2 Positioners

Series	Material	Width	Version
5262	*	0085	C
5262	*	0170	C
5262	*	0255	C
5262	*	0340	C
5262	*	0425	C
5262	*	0510	C
5262	*	0595	C
5262	*	0680	C
5262	*	0765	C
5262	*	0850	C
5262	*	0935	C
5262	*	1020	C
5262	*	1105	C
5262	*	1190	C
5262	*	1275	C
5262	*	1360	C
5262	*	1445	C
5262	*	1530	C

525 HD GT

Tappeti modulari / Modular belts / Mattenketten

525 HD GT Tappeto Modulare 525 HD GT, H=8,7 M=85

Modular Belt Series 525 HD GT, H=8,7 M=85 / Modulare Mattenkette 525 HD GT, H=8,7 M=85

Metric Size

CODE STRUCTURE GUIDE			
(Example)			
5263	03	0340	C
Series	*Material	Width	Version

Backflex radius min.: 25 mm



pg. 222

pg. 420->428

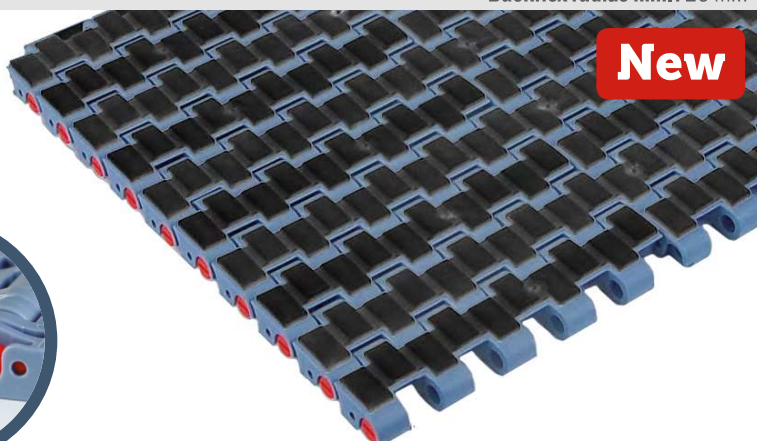

New

*Material

LFA - Code 01

Low friction Acetal

Max w. load: 25500 N/m
Weight: 9,0 kg/m²
Temp. range: dry -40÷80 °C
 wet -40÷65 °C
Pin material: PBT white
Hardness of
Grip top Rubber: 75 Sha

PP - Code 02

Polypropylene

Max w. load: 15500 N/m
Weight: 8,5 kg/m²
Temp. range: dry 4÷80 °C
 wet 4÷65 °C
Pin material: PP blu
Hardness of
Grip top Rubber: 75 Sha

MX - Code 03

Performance PBT

Max w. load: 20500 N/m
Weight: 8,7 kg/m²
Temp. range: dry -40÷120 °C
 wet -40÷60 °C
Pin material: POM grey
Hardness of
Grip top Rubber: 75 Sha

Version A - Standard

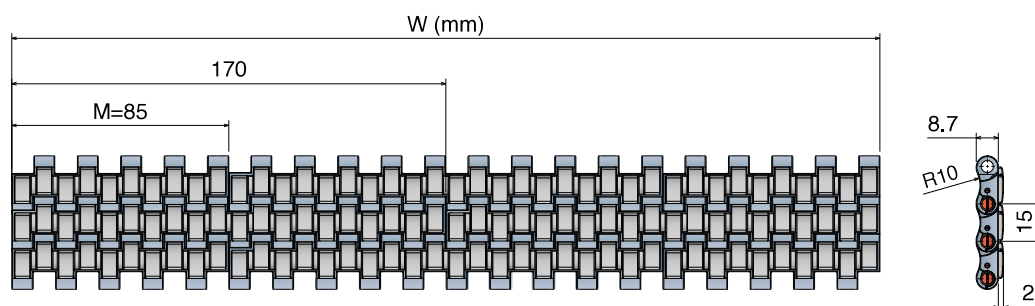

Version B - With 1 Positioner

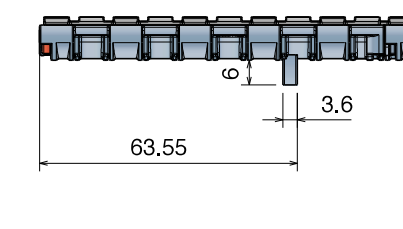

Version C - With 2 Positioners

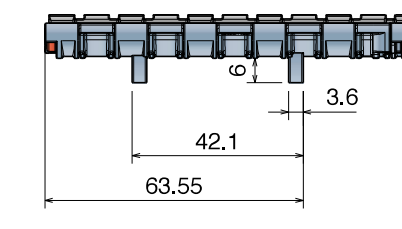

Version A - Standard

Series	Material	Width	Version
5263	*	0085	A
5263	*	0170	A
5263	*	0255	A
5263	*	0340	A
5263	*	0425	A
5263	*	0510	A
5263	*	0595	A
5263	*	0680	A
5263	*	0765	A
5263	*	0850	A
5263	*	0935	A
5263	*	1020	A
5263	*	1105	A
5263	*	1190	A
5263	*	1275	A
5263	*	1360	A
5263	*	1445	A
5263	*	1530	A

Version B - With 1 Positioner

Series	Material	Width	Version
5263	*	0085	B
5263	*	0170	B
5263	*	0255	B
5263	*	0340	B
5263	*	0425	B
5263	*	0510	B
5263	*	0595	B
5263	*	0680	B
5263	*	0765	B
5263	*	0850	B
5263	*	0935	B
5263	*	1020	B
5263	*	1105	B
5263	*	1190	B
5263	*	1275	B
5263	*	1360	B
5263	*	1445	B
5263	*	1530	B

Version C - With 2 Positioners

Series	Material	Width	Version
5263	*	0085	C
5263	*	0170	C
5263	*	0255	C
5263	*	0340	C
5263	*	0425	C
5263	*	0510	C
5263	*	0595	C
5263	*	0680	C
5263	*	0765	C
5263	*	0850	C
5263	*	0935	C
5263	*	1020	C
5263	*	1105	C
5263	*	1190	C
5263	*	1275	C
5263	*	1360	C
5263	*	1445	C
5263	*	1530	C

525 HD GT Side indent

Tappeto Modulare 525 HD GT Side Indent, H=8,7 M=85
 Modular Belt Series 525 HD GT Side Indent, H=8,7 M=85 / Modulare Mattenkette 525 HD GT Side Indent, H=8,7 M=85

Metric Size

CODE STRUCTURE GUIDE			
(Example)			
5265	03	0340	C
Series	*Material	Width	Version

Backflex radius min.: 25 mm

New

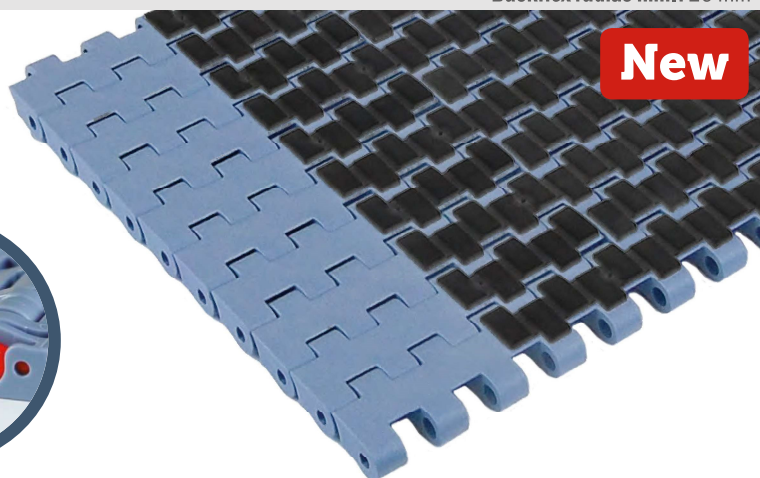

*Material

LFA - Code 01

Low friction Acetal

Max w. load: 25500 N/m
 Weight: 9,0 kg/m²
 Temp. range: dry -40÷80 °C
 wet -40÷65 °C
 Pin material: PBT white
 Hardness of
 Grip top Rubber: 75 Sha

PP - Code 02

Polypropylene

Max w. load: 15500 N/m
 Weight: 8,5 kg/m²
 Temp. range: dry 4÷80 °C
 wet 4÷65 °C
 Pin material: PP blu
 Hardness of
 Grip top Rubber: 75 Sha

MX - Code 03

Performance PBT

Max w. load: 20500 N/m
 Weight: 8,7 kg/m²
 Temp. range: dry -40÷120 °C
 wet -40÷60 °C
 Pin material: POM grey
 Hardness of
 Grip top Rubber: 75 Sha

Version A - Standard

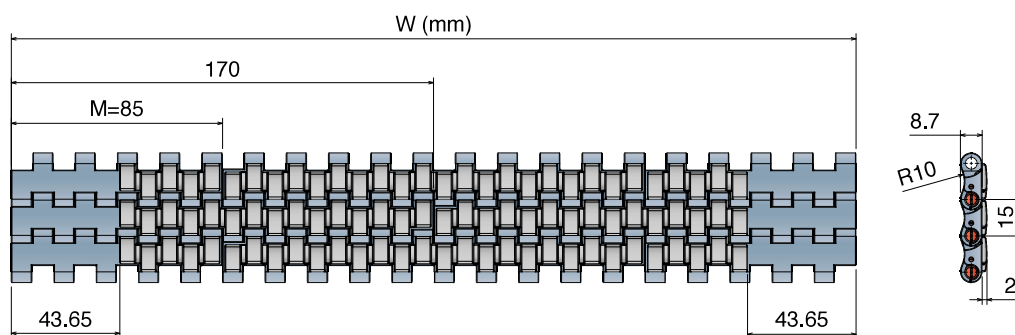

Version B - With 1 Positioner

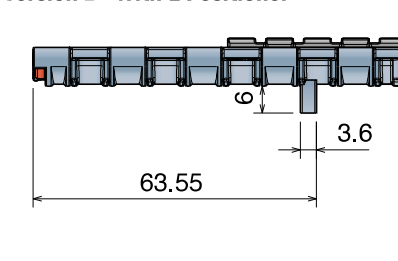

Version C - With 2 Positioner

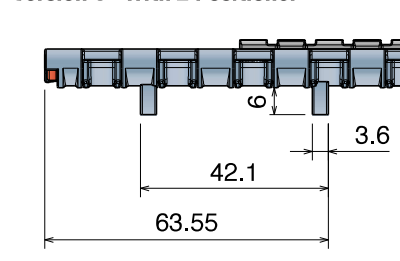

Version A - Standard

Series	Material	Width	Version
5265	*	0255	A
5265	*	0340	A
5265	*	0425	A
5265	*	0510	A
5265	*	0595	A
5265	*	0680	A
5265	*	0765	A
5265	*	0850	A
5265	*	0935	A
5265	*	1020	A
5265	*	1105	A
5265	*	1190	A
5265	*	1275	A
5265	*	1360	A
5265	*	1445	A
5265	*	1530	A

Version B - With 1 Positioner

Series	Material	Width	Version
5265	*	0255	B
5265	*	0340	B
5265	*	0425	B
5265	*	0510	B
5265	*	0595	B
5265	*	0680	B
5265	*	0765	B
5265	*	0850	B
5265	*	0935	B
5265	*	1020	B
5265	*	1105	B
5265	*	1190	B
5265	*	1275	B
5265	*	1360	B
5265	*	1445	B
5265	*	1530	B

Version C - With 2 Positioners

Series	Material	Width	Version
5265	*	0255	C
5265	*	0340	C
5265	*	0425	C
5265	*	0510	C
5265	*	0595	C
5265	*	0680	C
5265	*	0765	C
5265	*	0850	C
5265	*	0935	C
5265	*	1020	C
5265	*	1105	C
5265	*	1190	C
5265	*	1275	C
5265	*	1360	C
5265	*	1445	C
5265	*	1530	C

530

Imperial Size

Pitch 15 mm
H= 8,7 mm

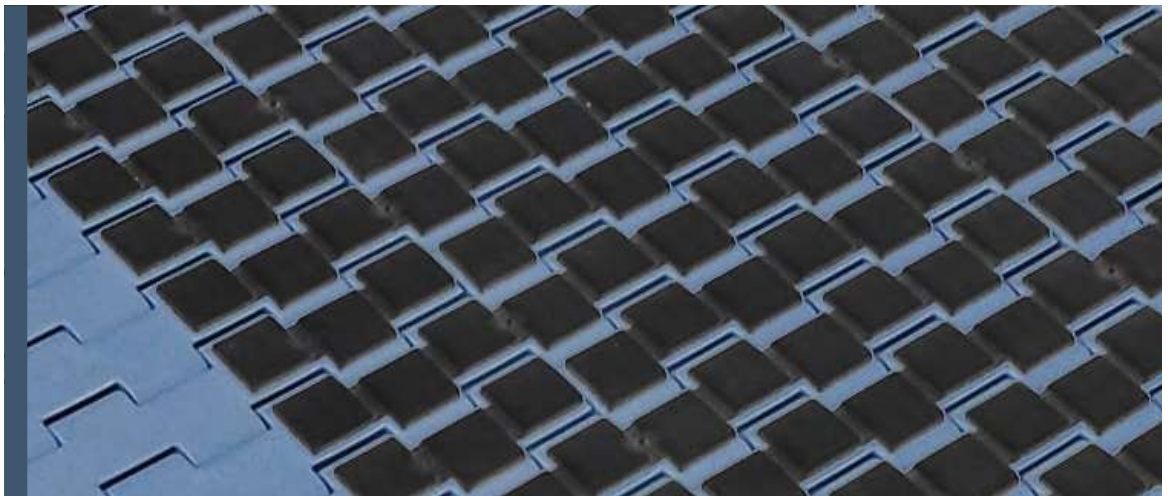

530 FT
530 FTT
530 GT
550 GT *Side indent*
530 LBP

530 FT

Tappeto Modulare 530 FT, H=8,7 M=3"
 Modular Belt Series 530 FT, H=8,7 M=3" / Modulare Mattenkette 530 FT, H=8,7 M=3"

Imperial Size

CODE STRUCTURE GUIDE			
(Example)			
5321	01	0030	A
Series	*Material	Width	Version

Backflex radius min.: 25 mm

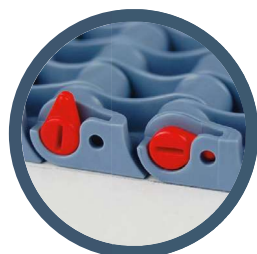
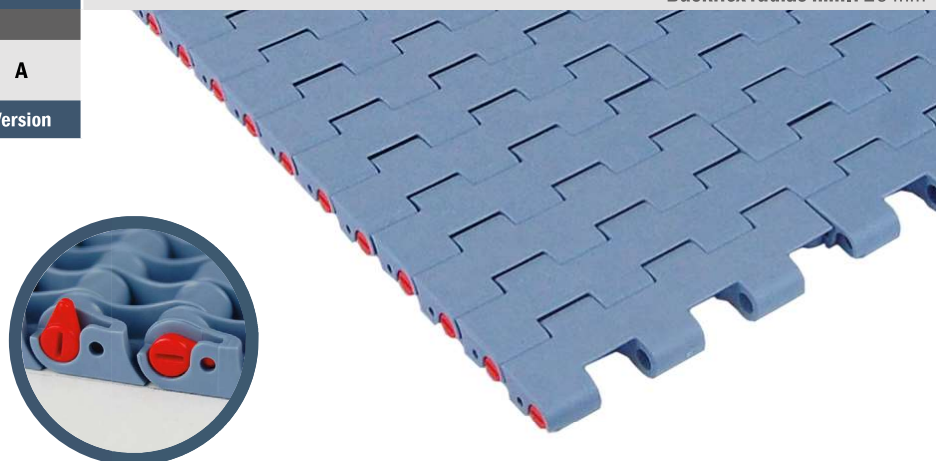

***Material**

LFA - Code 01

Low friction Acetal

Max w. load: 26000 N/m
Weight: 9,2 kg/m²
Temp. range: dry -40÷80 °C
 wet -40÷65 °C
Pin material: PBT white

MX - Code 03

Performance PBT

Max w. load: 21000 N/m
Weight: 9,0 kg/m²
Temp. range: dry -40÷120 °C
 wet -40÷60 °C
Pin material: POM grey

MK - Code 08

Super Performance Acetal

Max w. load: 25000 N/m
Weight: 9,2 kg/m²
Temp. range: dry -40÷80 °C
 wet -40÷65 °C
Pin material: PBT white

MPX - Code 25

Lubricated Acetal

Max w. load: 26000 N/m
Weight: 9,2 kg/m²
Temp. range: dry -40÷80 °C
 wet -40÷65 °C
Pin material: PBT white

DKM - Code 16

Aramide Reinforced Acetal

Max w. load: 26000 N/m
Weight: 9,2 kg/m²
Temp. range: dry -40÷80 °C
 wet -40÷65 °C
Pin material: PBT white

MWX - Code 17

Polyamide Composite

Max w. load: 26000 N/m
Weight: 9,5 kg/m²
Temp. range: dry -40÷104 °C
 wet NR
Pin material: PBT white

Version A - Standard

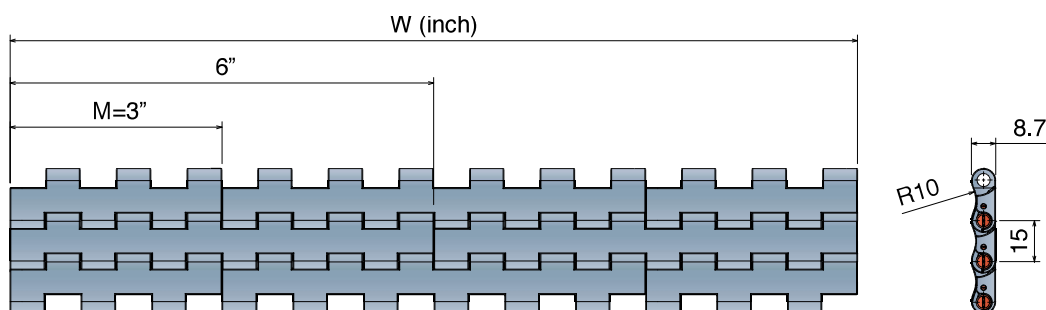

Version A - Standard

Series	Material	Width	Version
5321	*	0003	A
5321	*	0006	A
5321	*	0009	A
5321	*	0012	A
5321	*	0015	A
5321	*	0018	A
5321	*	0021	A
5321	*	0024	A
5321	*	0027	A
5321	*	0030	A
5321	*	0033	A
5321	*	0036	A
5321	*	0039	A
5321	*	0042	A
5321	*	0045	A
5321	*	0048	A
5321	*	0051	A
5321	*	0054	A

530 FTT

Tappeto Modulare 530 FTT, H=8,7 M=3"
 Modular Belt Series 530 FTT, H=8,7 M=3" / Modulare Mattenkette 530 FTT, H=8,7 M=3"

Imperial Size

CODE STRUCTURE GUIDE			
(Example)			
5326	01	0006	A
Series	*Material	Width	Version

Backflex radius min.: 25 mm



pg. 222

pg. 420->428

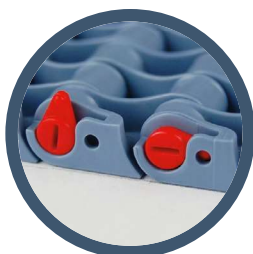

Version A - Standard

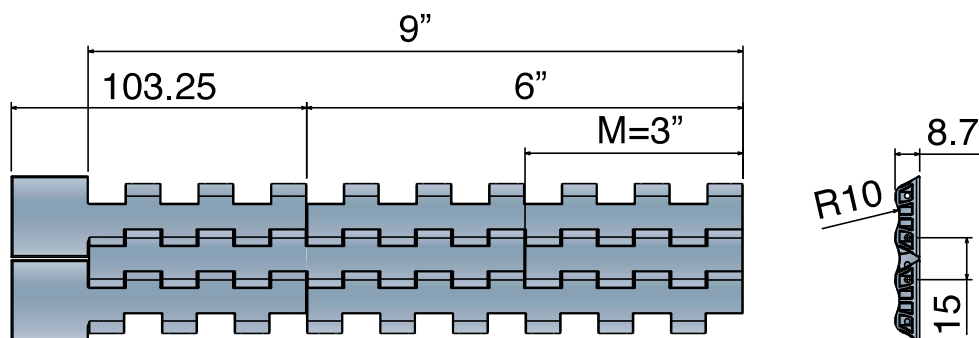

*Material

LFA - Code 01

Low friction Acetal

Max w. load: 26000 N/m
 Weight: 9,2 kg/m²
 Temp. range: dry -40÷80 °C
 wet -40÷65 °C
 Pin material: PBT white

MX - Code 03

Performance PBT

Max w. load: 21000 N/m
 Weight: 9,0 kg/m²
 Temp. range: dry -40÷120 °C
 wet -40÷60 °C
 Pin material: POM grey

MK - Code 08

Super Performance Acetal

Max w. load: 25000 N/m
 Weight: 9,2 kg/m²
 Temp. range: dry -40÷80 °C
 wet -40÷65 °C
 Pin material: PBT white

MPX - Code 25

Lubricated Acetal

Max w. load: 26000 N/m
 Weight: 9,2 kg/m²
 Temp. range: dry -40÷80 °C
 wet -40÷65 °C
 Pin material: PBT white

DKM - Code 16

Aramide Reinforced Acetal

Max w. load: 26000 N/m
 Weight: 9,2 kg/m²
 Temp. range: dry -40÷80 °C
 wet -40÷65 °C
 Pin material: PBT white

MWX - Code 17

Polyamide Composite

Max w. load: 26000 N/m
 Weight: 9,5 kg/m²
 Temp. range: dry -40÷104 °C
 wet NR
 Pin material: PBT white

Version A - Standard

Series	Material	Width	Version
5326	*	0003	A
5326	*	0006	A
5326	*	0009	A

530 GT

Tappeto Modulare 530 GT, H=8,7 M=3"
 Modular Belt Series 530 GT, H=8,7 M=3" / Modulare Mattenkette 530 GT, H=8,7 M=3"

Imperial Size

CODE STRUCTURE GUIDE			
(Example)			
5323	01	0009	A
Series	*Material	Width	Version

Backflex radius min.: 30 mm

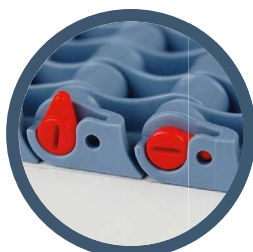
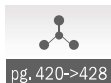
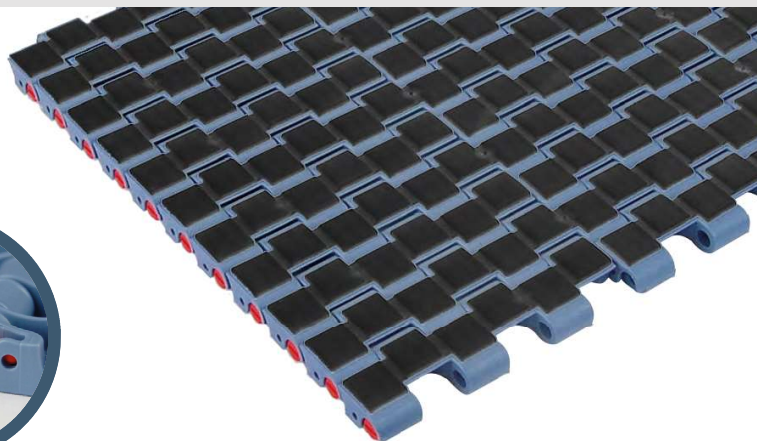

*Material

LFA - Code 01

Low friction Acetal

Max w. load: 26000 N/m
 Weight: 9,2 kg/m²
 Temp. range: dry -40÷80 °C
 wet -40÷65 °C
 Pin material: PBT white
 Hardness of
 Grip top Rubber: 75 Sha

PP - Code 02

Polypropylene

Max w. load: 15500 N/m
 Weight: 8,6 kg/m²
 Temp. range: dry 4÷80 °C
 wet 4÷65 °C
 Pin material: PP blu
 Hardness of
 Grip top Rubber: 75 Sha

MX - Code 03

Performance PBT

Max w. load: 21000 N/m
 Weight: 9,0 kg/m²
 Temp. range: dry -40÷120 °C
 wet -40÷60 °C
 Pin material: POM grey
 Hardness of
 Grip top Rubber: 75 Sha

Version A - Standard

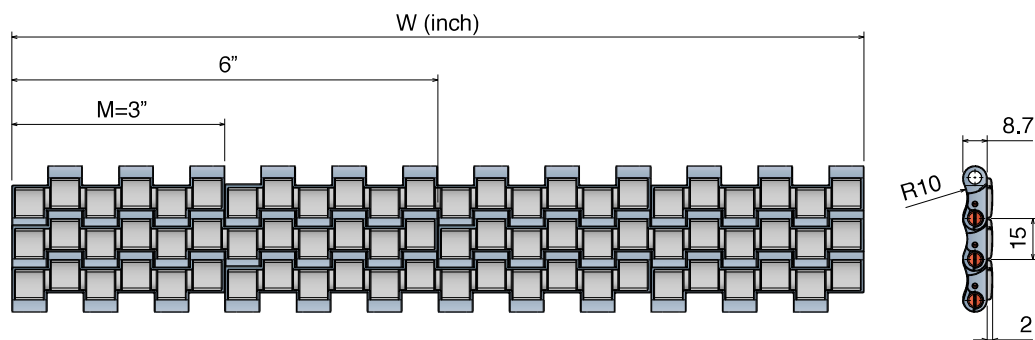

Version A - Standard

Series	Material	Width	Version
5323	*	0003	A
5323	*	0006	A
5323	*	0009	A
5323	*	0012	A
5323	*	0015	A
5323	*	0018	A
5323	*	0021	A
5323	*	0024	A
5323	*	0027	A
5323	*	0030	A
5323	*	0033	A
5323	*	0036	A
5323	*	0039	A
5323	*	0042	A
5323	*	0045	A
5323	*	0048	A
5323	*	0051	A
5323	*	0054	A

530 GT Side indent

Tappeti modulari / Modular belts / Mattenketten

530 GT Side indent Tappeto Modulare 530 GT, H=8,7 M=3"

Modular Belt Series 530 GT, H=8,7 M=3" / Modulare Mattenkette 530 GT, H=8,7 M=3"

Imperial Size

CODE STRUCTURE GUIDE

(Example)

5325	01	0027	A
Series	*Material	Width	Version

Backflex radius min.: 30 mm



pg. 222



pg. 420->428

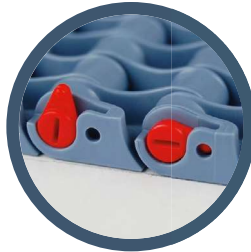
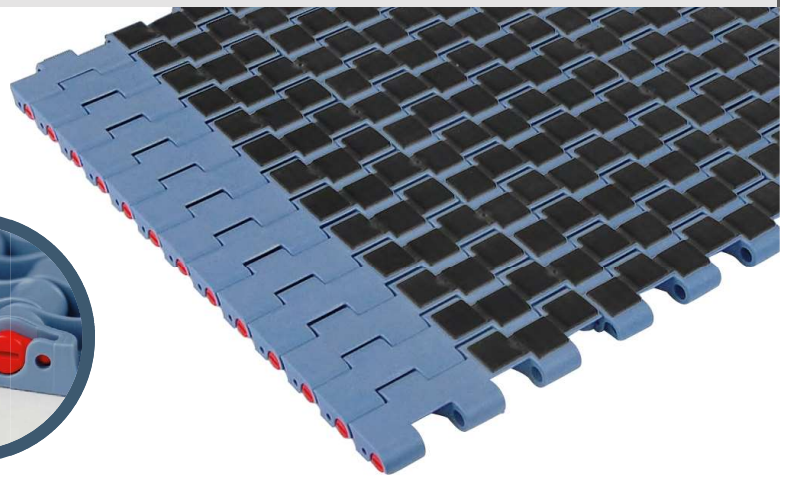

*Material

LFA - Code 01

Low friction Acetal

Max w. load: 26000 N/m
Weight: 9,2 kg/m²
Temp. range: dry -40+80 °C
 wet -40+65 °C
Pin material: PBT white
Hardness of
Grip top Rubber: 75 ShA

PP - Code 02

Polypropylene

Max w. load: 15500 N/m
Weight: 8,6 kg/m²
Temp. range: dry 4+80 °C
 wet 4+65 °C
Pin material: PP blu
Hardness of
Grip top Rubber: 75 ShA

MX - Code 03

Performance PBT

Max w. load: 21000 N/m
Weight: 9,0 kg/m²
Temp. range: dry -40+120 °C
 wet -40+60 °C
Pin material: POM grey
Hardness of
Grip top Rubber: 75 ShA

Version A - Standard

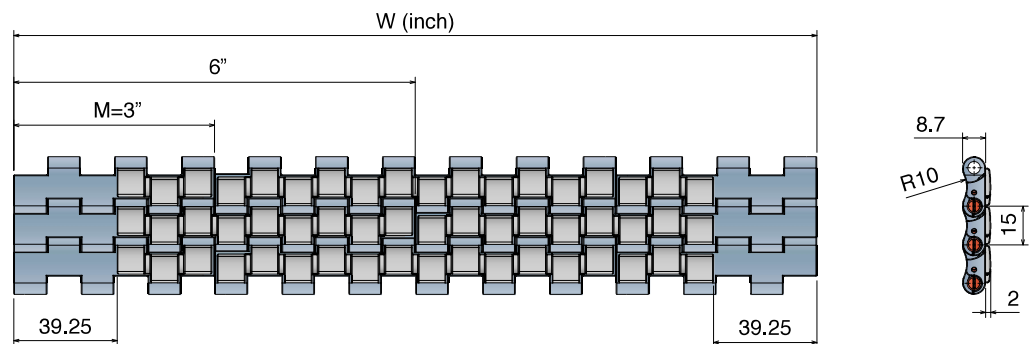

Version A - Standard

Series	Material	Width	Version
5325	*	0009	A
5325	*	0012	A
5325	*	0015	A
5325	*	0018	A
5325	*	0021	A
5325	*	0024	A
5325	*	0027	A
5325	*	0030	A
5325	*	0033	A
5325	*	0036	A
5325	*	0039	A
5325	*	0042	A
5325	*	0045	A
5325	*	0048	A
5325	*	0051	A
5325	*	0054	A

530 LBP

Tappeto Modulare 530 LBP, H=8,7 M=3"
 Modular Belt Series 530 LBP, H=8,7 M=3" / Modulare Mattenkette 530 LBP, H=8,7 M=3"

Imperial Size

CODE STRUCTURE GUIDE			
(Example)			
5324	01	0012	A
Series	*Material	Width	Version

Backflex radius min.: 25 mm

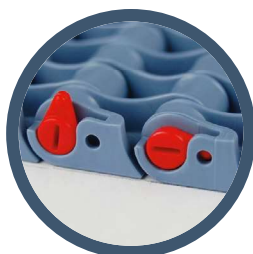
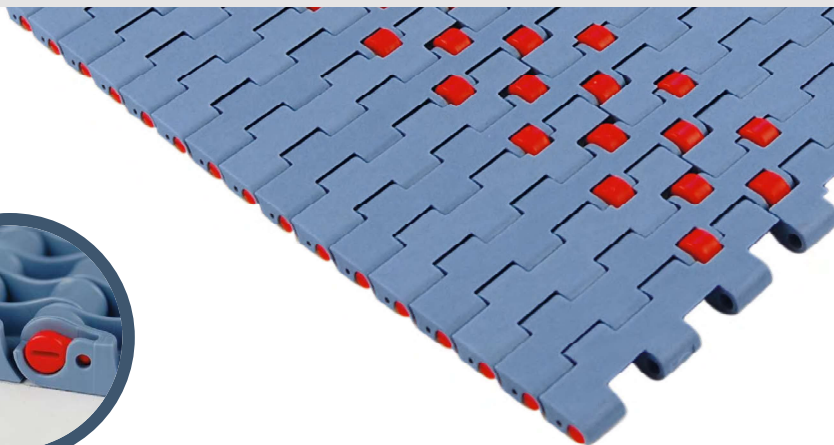

Version A - Standard

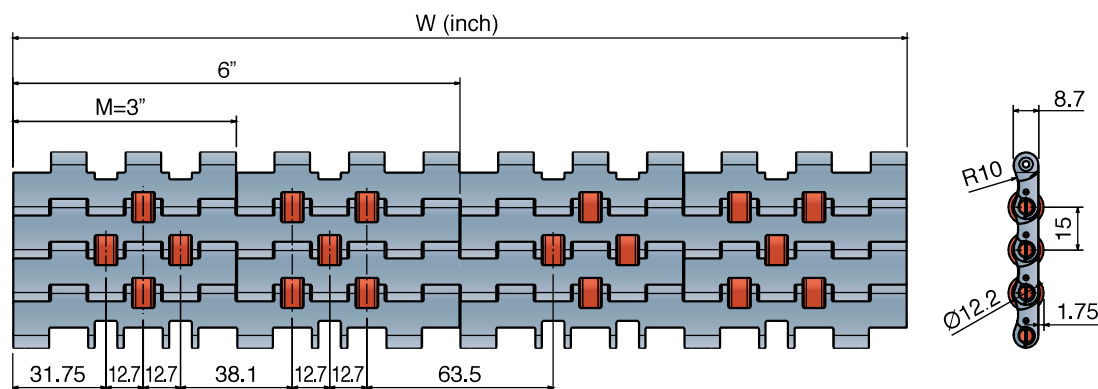

Version A - Standard

*Material

LFA - Code 01
 Low friction Acetal

Max w. load: 26000 N/m
 Weight: 9,2 kg/m²
 Temp. range: dry -40÷80 °C
 wet -40÷65 °C
 Pin material: PBT white
 Hardness: 75 ShA

Series	Material	Width	Version
5324	*	0006	A
5324	*	0012	A
5324	*	0018	A
5324	*	0024	A
5324	*	0030	A
5324	*	0036	A
5324	*	0042	A
5324	*	0048	A
5324	*	0054	A

550

Metric Size

Pitch 25,4 mm
H= 8,7 mm

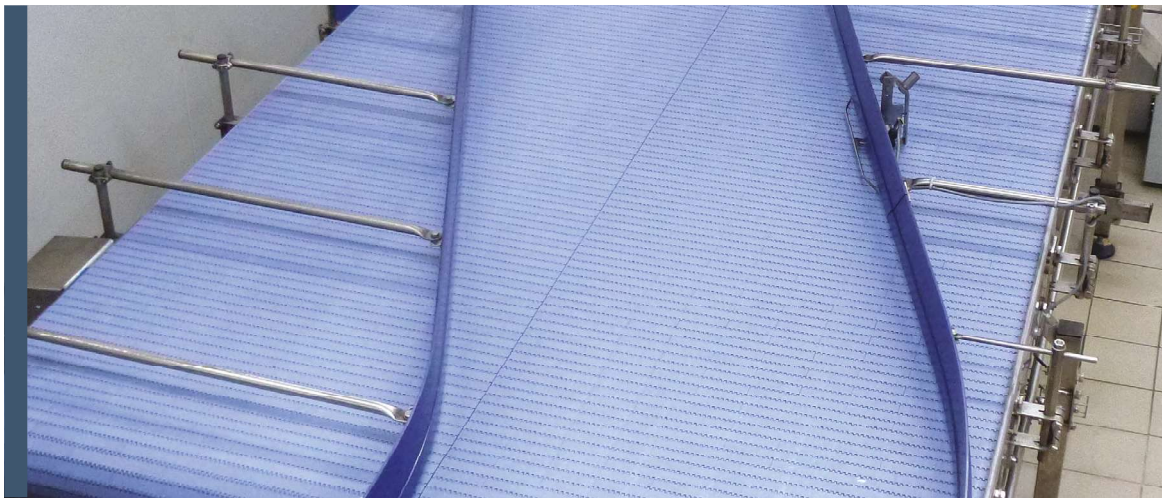

550 FT

550 *One track Belt*

550 FTT

550 FG

550 FG *One track Belt*

550 GT

550 GT *Side indent*

550 FT

Tappeto Modulare 550 FT, H=8,7 M=85
 Modular Belt Series 550 FT, H=8,7 M=85 / Modulare Mattenkette 550 FT, H=8,7 M=85

Metric Size

CODE STRUCTURE GUIDE			
(Example)			
5221	08	0255	A
Series	*Material	Width	Version

Backflex radius min.: 25 mm

pg. 224-225

pg. 420->428

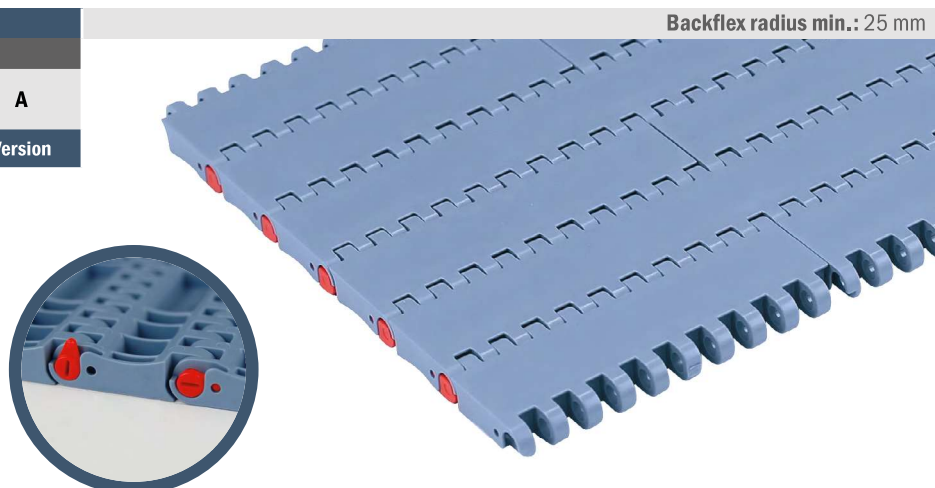

*Material

LFA - Code 01

Low friction Acetal

Max w. load: 27500 N/m
 Weight: 8,5 kg/m²
 Temp. range: dry -40÷80 °C
 wet -40÷65 °C
 Pin material: PBT white

MX - Code 03

Performance PBT

Max w. load: 22000 N/m
 Weight: 8,2 kg/m²
 Temp. range: dry -40÷120 °C
 wet -40÷60 °C
 Pin material: POM grey

MK - Code 08

Super Performance Acetal

Max w. load: 26500 N/m
 Weight: 8,5 kg/m²
 Temp. range: dry -40÷80 °C
 wet -40÷65 °C
 Pin material: PBT white

MPX - Code 25

Lubricated Acetal

Max w. load: 27500 N/m
 Weight: 8,5 kg/m²
 Temp. range: dry -40÷80 °C
 wet -40÷65 °C
 Pin material: PBT white

DKM - Code 16

Aramide Reinforced Acetal

Max w. load: 27500 N/m
 Weight: 8,5 kg/m²
 Temp. range: dry -40÷80 °C
 wet -40÷65 °C
 Pin material: PBT white

MWX - Code 17

Polyamide Composite

Max w. load: 27500 N/m
 Weight: 8,9 kg/m²
 Temp. range: dry -40÷104 °C
 wet NR
 Pin material: PBT white

Version A - Standard

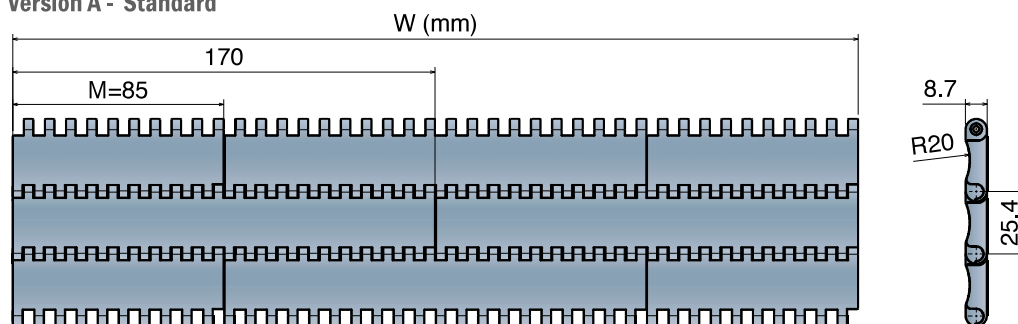

Version B - With 1 Positioner

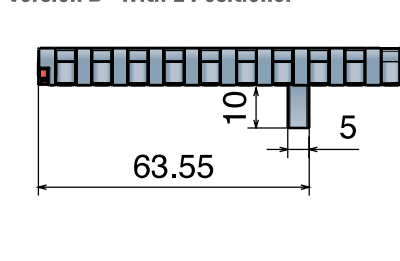

Version C - With 2 Positioner

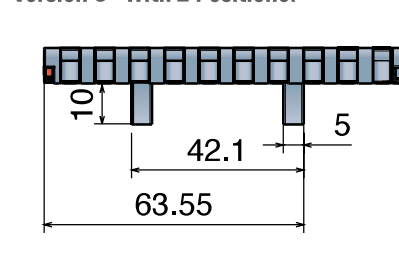

Version A - Standard

Series	Material	Width	Version
5221	*	0085	A
5221	*	0170	A
5221	*	0255	A
5221	*	0340	A
5221	*	0425	A
5221	*	0510	A
5221	*	0595	A
5221	*	0680	A
5221	*	0765	A
5221	*	0850	A
5221	*	0935	A
5221	*	1020	A
5221	*	1105	A
5221	*	1190	A
5221	*	1275	A
5221	*	1360	A
5221	*	1445	A
5221	*	1530	A

Version B - With 1 Positioner

Series	Material	Width	Version
5221	*	0085	B
5221	*	0170	B
5221	*	0255	B
5221	*	0340	B
5221	*	0425	B
5221	*	0510	B
5221	*	0595	B
5221	*	0680	B
5221	*	0765	B
5221	*	0850	B
5221	*	0935	B
5221	*	1020	B
5221	*	1105	B
5221	*	1190	B
5221	*	1275	B
5221	*	1360	B
5221	*	1445	B
5221	*	1530	B

Version C - With 2 Positioners

Series	Material	Width	Version
5221	*	0085	C
5221	*	0170	C
5221	*	0255	C
5221	*	0340	C
5221	*	0425	C
5221	*	0510	C
5221	*	0595	C
5221	*	0680	C
5221	*	0765	C
5221	*	0850	C
5221	*	0935	C
5221	*	1020	C
5221	*	1105	C
5221	*	1190	C
5221	*	1275	C
5221	*	1360	C
5221	*	1445	C
5221	*	1530	C

550 FT One track Belt

Tappeti modulari / Modular belts / Mattenketten

550 FT One track Belt

Tappeto Modulare 550 FT, H=8,7 K330
Modular Belt Series 550 FT, H=8,7 K330 / Modulare Mattenkette 550 FT, H=8,7 K330

Metric Size

CODE STRUCTURE GUIDE			
(Example)			
5221	03	9330	A
Series	*Material	Width	Version

Backflex radius min.: 25 mm



pg. 224-225 pg. 420->428

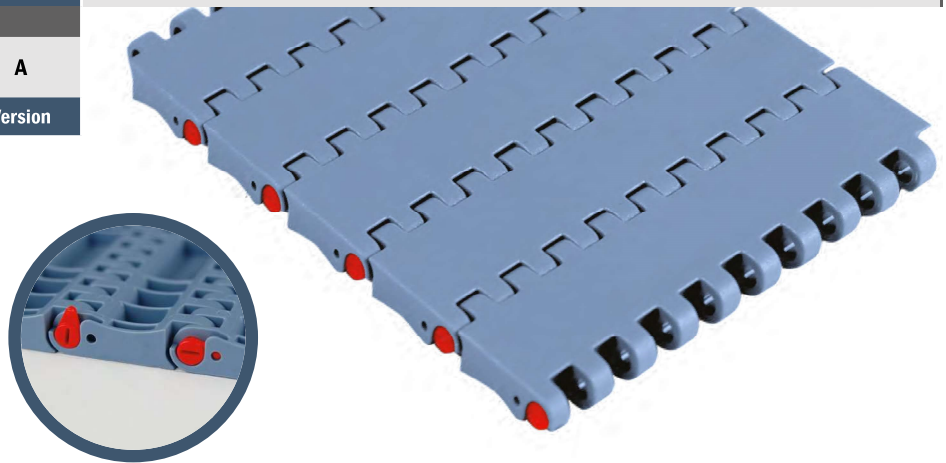

*Material

LFA - Code 01

Low friction Acetal

Max w. load: 27500 N/m
Weight: 8,5 kg/m²
Temp. range: dry -40÷80 °C
wet -40÷65 °C
Pin material: PBT white

MX - Code 03

Performance PBT

Max w. load: 22000 N/m
Weight: 8,2 kg/m²
Temp. range: dry -40÷120 °C
wet -40÷60 °C
Pin material: POM grey

MK - Code 08

Super Performance Acetal

Max w. load: 26500 N/m
Weight: 8,5 kg/m²
Temp. range: dry -40÷80 °C
wet -40÷65 °C
Pin material: PBT white

MPX - Code 25

Lubricated Acetal

Max w. load: 27500 N/m
Weight: 8,5 kg/m²
Temp. range: dry -40÷80 °C
wet -40÷65 °C
Pin material: PBT white

DKM - Code 16

Aramide Reinforced Acetal

Max w. load: 27500 N/m
Weight: 8,5 kg/m²
Temp. range: dry -40÷80 °C
wet -40÷65 °C
Pin material: PBT white

MWX - Code 17

Polyamide Composite

Max w. load: 27500 N/m
Weight: 8,9 kg/m²
Temp. range: dry -40÷104 °C
wet NR
Pin material: PBT white

Version A - Standard

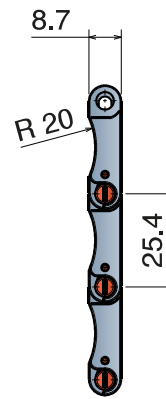
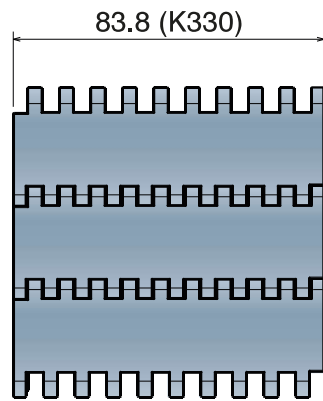

Version C - With 2 Positioner

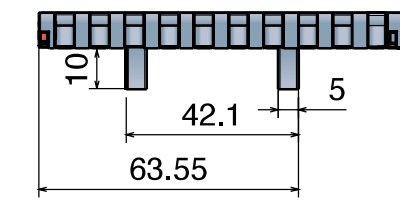

Version A - Standard

Series	Material	Width	Version
5221	*	9330	A

Version C - With 2 Positioners

Series	Material	Width	Version
5221	*	9330	C

550 FTT

Tappeto Modulare 550 FTT, H=8,7 M=85
 Modular Belt Series 550 FTT, H=8,7 M=85 / Modulare Mattenkette 550 FTT, H=8,7 M=85

Metric Size

CODE STRUCTURE GUIDE			
(Example)			
5226	03	0255	CN
Series	*Material	Width	Version

Backflex radius min.: 25 mm



pg. 224-225

pg. 420->428

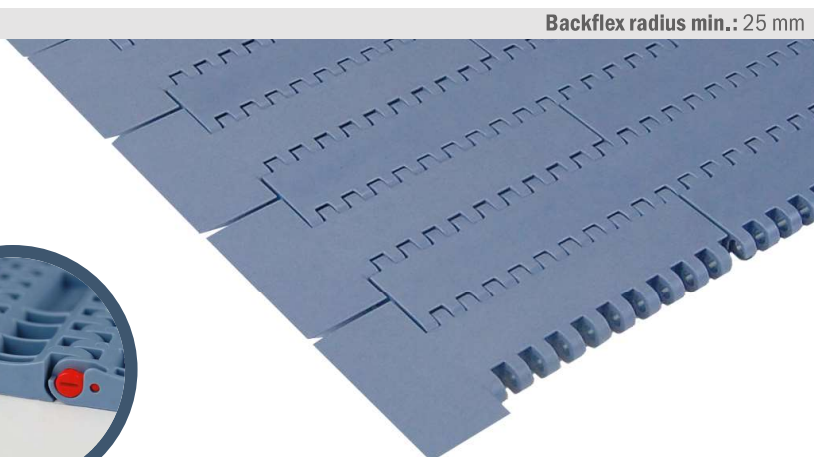
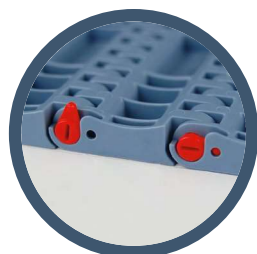

*Material

LFA - Code 01

Low friction Acetal

Max w. load: 27500 N/m
 Weight: 8,5 kg/m²
 Temp. range: dry -40÷80 °C
 wet -40÷65 °C
 Pin material: PBT white

MX - Code 03

Performance PBT

Max w. load: 22000 N/m
 Weight: 8,2 kg/m²
 Temp. range: dry -40÷120 °C
 wet -40÷60 °C
 Pin material: POM grey

MK - Code 08

Super Performance Acetal

Max w. load: 26500 N/m
 Weight: 8,5 kg/m²
 Temp. range: dry -40÷80 °C
 wet -40÷65 °C
 Pin material: PBT white

MPX - Code 25

Lubricated Acetal

Max w. load: 27500 N/m
 Weight: 8,5 kg/m²
 Temp. range: dry -40÷80 °C
 wet -40÷65 °C
 Pin material: PBT white

DKM - Code 16

Aramide Reinforced Acetal

Max w. load: 27500 N/m
 Weight: 8,5 kg/m²
 Temp. range: dry -40÷80 °C
 wet -40÷65 °C
 Pin material: PBT white

MWX - Code 17

Polyamide Composite

Max w. load: 27500 N/m
 Weight: 8,9 kg/m²
 Temp. range: dry -40÷104 °C
 wet NR
 Pin material: PBT white

Version C

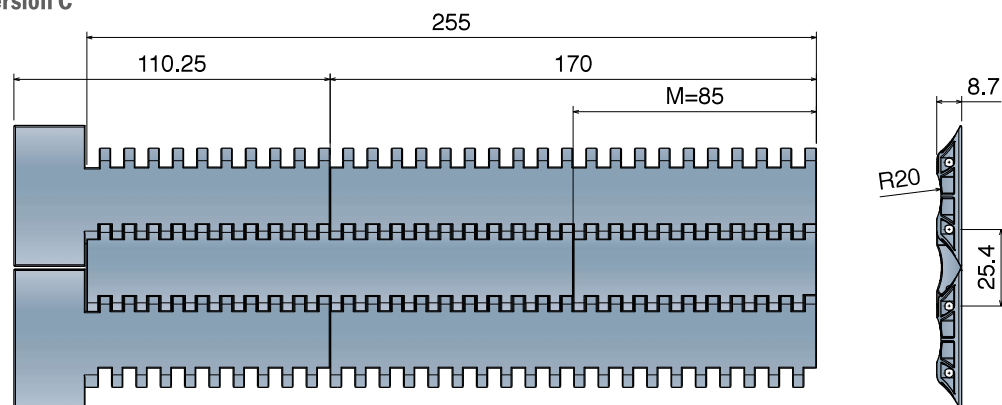

Version CN - Near



Version CO - Opposite



Version C

Series	Material	Width	Version
5226	*	0085	C

Version CN - Near

Series	Material	Width	Version
5226	*	0170	CN
5226	*	0255	CN

Version CO - Opposite

Series	Material	Width	Version
5226	*	0170	CO
5226	*	0255	CO

550 FG

Tappeto Modulare 550 FG, H=8,7 M=85
Modular Belt Series 550 FG, H=8,7 M=85 / Modulare Mattenkette 550 FG, H=8,7 M=85

Metric Size

CODE STRUCTURE GUIDE			
(Example)			
5222	01	0850	C
Series	*Material	Width	Version

Backflex radius min.: 25 mm



pg. 224-225

pg. 420->428

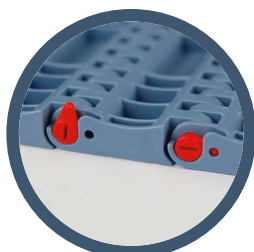
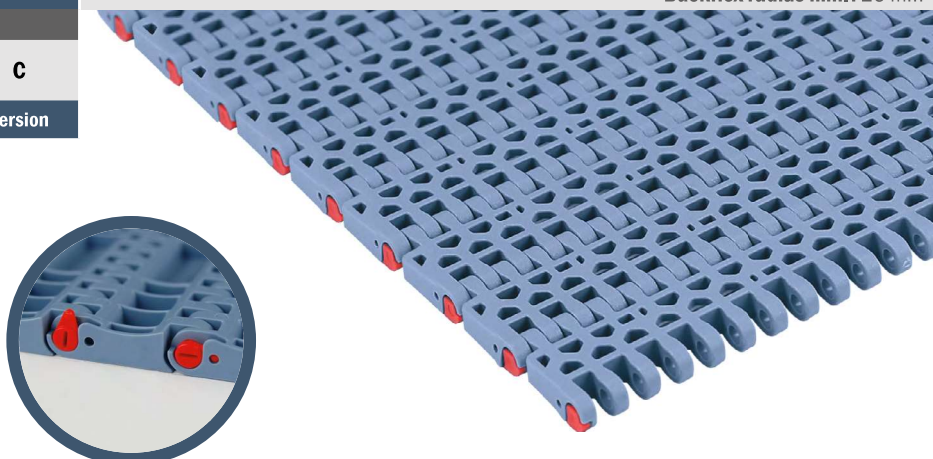

*Material

LFA - Code 01 Low friction Acetal

Max w. load: 27500 N/m
Weight: 7,0 kg/m²
Temp. range: dry -40÷80 °C
wet -40÷65 °C
Pin material: PBT white

MX - Code 03 Performance PBT

Max w. load: 22000 N/m
Weight: 6,7 kg/m²
Temp. range: dry -40÷120 °C
wet -40÷60 °C
Pin material: POM grey

MK - Code 08 Super Performance Acetal

Max w. load: 26500 N/m
Weight: 7,0 kg/m²
Temp. range: dry -40÷80 °C
wet -40÷65 °C
Pin material: PBT white

MPX - Code 25 Lubricated Acetal

Max w. load: 27500 N/m
Weight: 7,0 kg/m²
Temp. range: dry -40÷80 °C
wet -40÷65 °C
Pin material: PBT white

DKM - Code 16 Aramide Reinforced Acetal

Max w. load: 27500 N/m
Weight: 7,0 kg/m²
Temp. range: dry -40÷80 °C
wet -40÷65 °C
Pin material: PBT white

MWX - Code 17 Polyamide Composite

Max w. load: 27500 N/m
Weight: 7,3 kg/m²
Temp. range: dry -40÷104 °C
wet NR
Pin material: PBT white

Version A - Standard

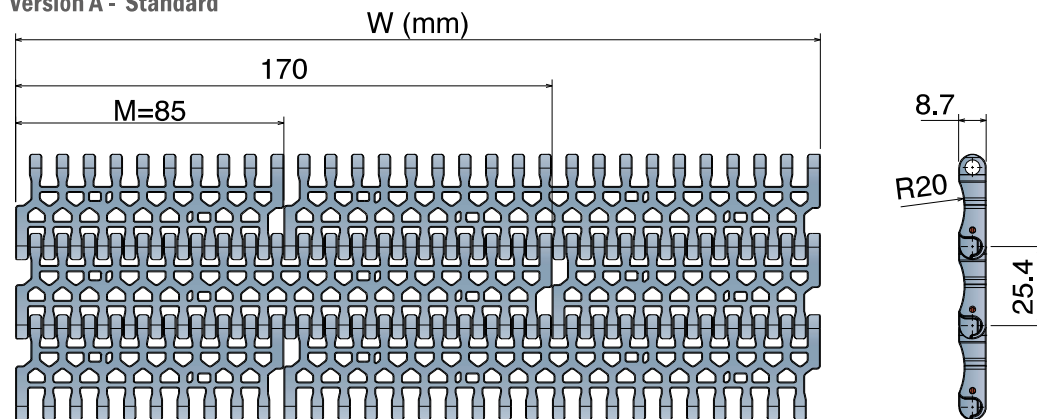

Version B - With 1 Positioner

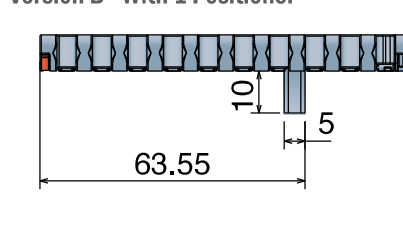

Version C - With 2 Positioners

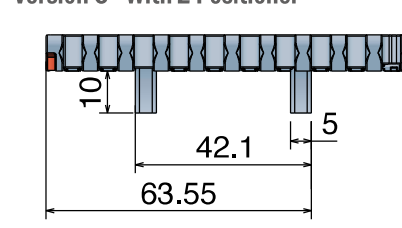

Version A - Standard

Series	Material	Width	Version
5222	*	0085	A
5222	*	0170	A
5222	*	0255	A
5222	*	0340	A
5222	*	0425	A
5222	*	0510	A
5222	*	0595	A
5222	*	0680	A
5222	*	0765	A
5222	*	0850	A
5222	*	0935	A
5222	*	1020	A
5222	*	1105	A
5222	*	1190	A
5222	*	1275	A
5222	*	1360	A
5222	*	1445	A
5222	*	1530	A

Version B - With 1 Positioner

Series	Material	Width	Version
5222	*	0085	B
5222	*	0170	B
5222	*	0255	B
5222	*	0340	B
5222	*	0425	B
5222	*	0510	B
5222	*	0595	B
5222	*	0680	B
5222	*	0765	B
5222	*	0850	B
5222	*	0935	B
5222	*	1020	B
5222	*	1105	B
5222	*	1190	B
5222	*	1275	B
5222	*	1360	B
5222	*	1445	B
5222	*	1530	B

Version C - With 2 Positioners

Series	Material	Width	Version
5222	*	0085	C
5222	*	0170	C
5222	*	0255	C
5222	*	0340	C
5222	*	0425	C
5222	*	0510	C
5222	*	0595	C
5222	*	0680	C
5222	*	0765	C
5222	*	0850	C
5222	*	0935	C
5222	*	1020	C
5222	*	1105	C
5222	*	1190	C
5222	*	1275	C
5222	*	1360	C
5222	*	1445	C
5222	*	1530	C

550 FG One track Belt

Tappeto Modulare 550 FG, H=8,7 K330
Modular Belt Series 550 FG, H=8,7 K330 / Modulare Mattenkette 550 FG, H=8,7 K330

Metric Size

CODE STRUCTURE GUIDE

(Example)

5222	01	9330	A
Series	*Material	Width	Version

Backflex radius min.: 25 mm



pg. 224-225

pg. 420->428

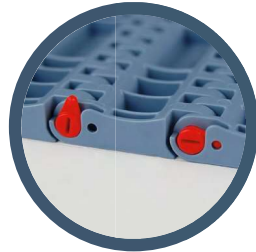
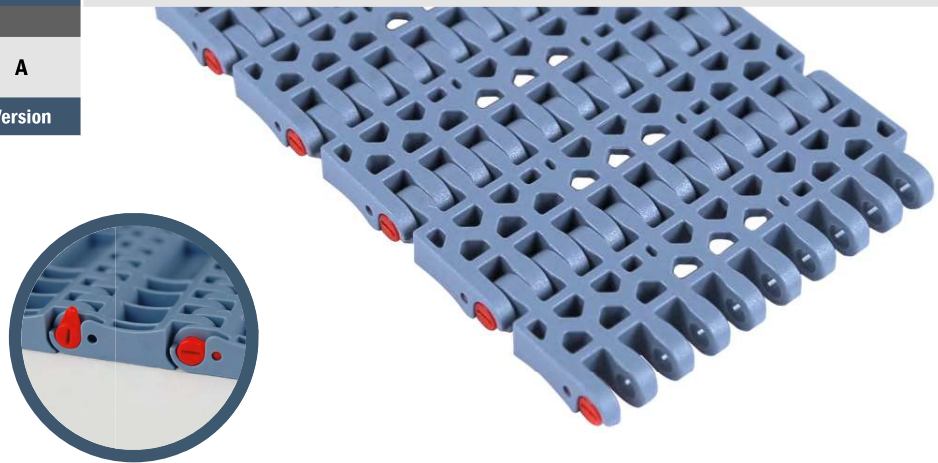

*Material

LFA - Code 01

Low friction Acetal

Max w. load: 27500 N/m
Weight: 7,0 kg/m²
Temp. range: dry -40÷80 °C
wet -40÷65 °C
Pin material: PBT white

MX - Code 03

Performance PBT

Max w. load: 22000 N/m
Weight: 6,7 kg/m²
Temp. range: dry -40÷120 °C
wet -40÷60 °C
Pin material: POM grey

MK - Code 08

Super Performance Acetal

Max w. load: 26500 N/m
Weight: 7,0 kg/m²
Temp. range: dry -40÷80 °C
wet -40÷65 °C
Pin material: PBT white

MPX - Code 25

Lubricated Acetal

Max w. load: 27500 N/m
Weight: 7,0 kg/m²
Temp. range: dry -40÷80 °C
wet -40÷65 °C
Pin material: PBT white

DKM - Code 16

Aramide Reinforced Acetal

Max w. load: 27500 N/m
Weight: 7,0 kg/m²
Temp. range: dry -40÷80 °C
wet -40÷65 °C
Pin material: PBT white

MWX - Code 17

Polyamide Composite

Max w. load: 27500 N/m
Weight: 7,3 kg/m²
Temp. range: dry -40÷104 °C
wet NR
Pin material: PBT white

Version A - Standard

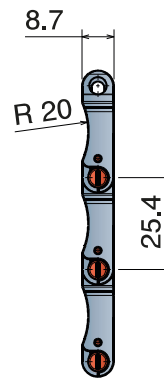
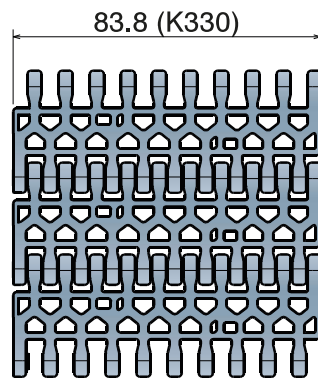

Version C - With 2 Positioner

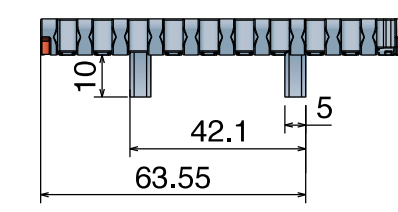

Version A - Standard

Series	Material	Width	Version
5222	*	9330	A

Version C - With 2 Positioners

Series	Material	Width	Version
5222	*	9330	C

550 GT

Tappeti modulari / Modular belts / Mattenketten

550 GT

Tappeto Modulare 550 GT, H=8,7 M=85

Modular Belt Series 550 GT, H=8,7 M=85 / Modulare Mattenkette 550 GT, H=8,7 M=85

Metric Size

CODE STRUCTURE GUIDE			
(Example)			
5223	02	1020	A
Series	*Material	Width	Version

Backflex radius min.: 30 mm



pg. 224-225

pg. 420->428

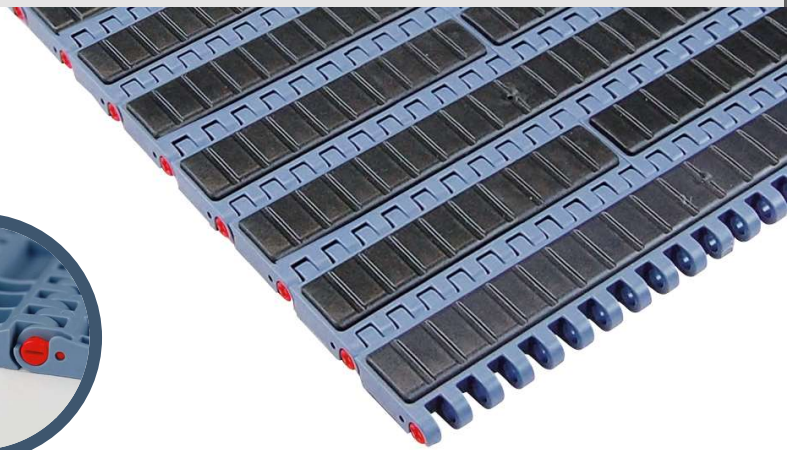

*Material

LFA - Code 01

Low friction Acetal

Max w. load: 27500 N/m
Weight: 10,1 kg/m²
Temp. range: dry -40+80 °C
wet -40+65 °C

Pin material: PBT white
Hardness of Grip top Rubber: 75 Sha

PP - Code 02

Polypropylene

Max w. load: 16500 N/m
Weight: 8,4 kg/m²
Temp. range: dry 4+80 °C
wet 4+65 °C

Pin material: PP blu
Hardness of Grip top Rubber: 75 Sha

MX - Code 03

Performance PBT

Max w. load: 21500 N/m
Weight: 10,5 kg/m²
Temp. range: dry -40+120 °C
wet -40+60 °C

Pin material: POM grey
Hardness of Grip top Rubber: 75 Sha

Version A - Standard

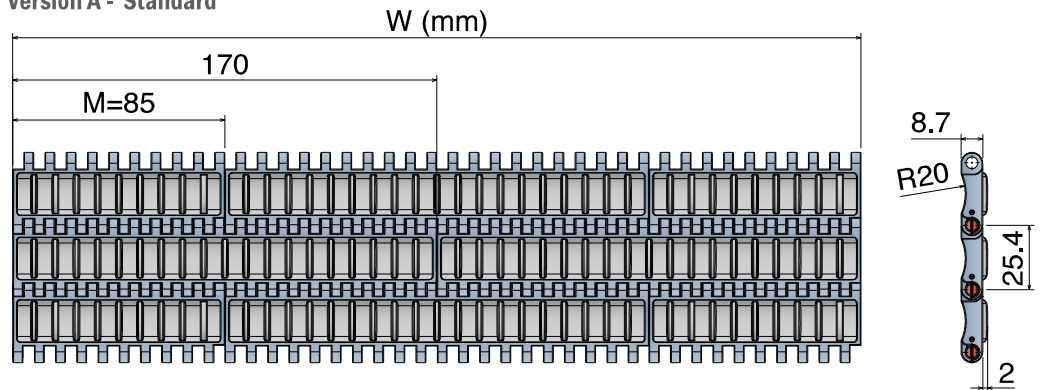

Version B - With 1 Positioner

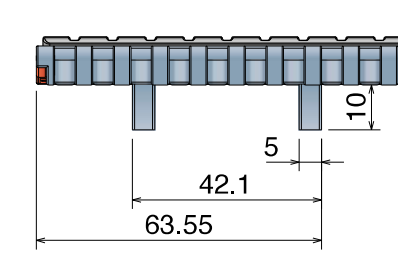

Version C - With 2 Positioners

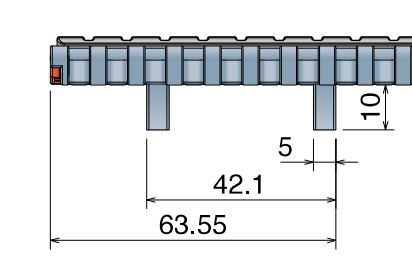

Version A - Standard

Series	Material	Width	Version
5223	*	0085	A
5223	*	0170	A
5223	*	0255	A
5223	*	0340	A
5223	*	0425	A
5223	*	0510	A
5223	*	0595	A
5223	*	0680	A
5223	*	0765	A
5223	*	0850	A
5223	*	0935	A
5223	*	1020	A
5223	*	1105	A
5223	*	1190	A
5223	*	1275	A
5223	*	1360	A
5223	*	1445	A
5223	*	1530	A

Version B - With 1 Positioner

Series	Material	Width	Version
5223	*	0085	B
5223	*	0170	B
5223	*	0255	B
5223	*	0340	B
5223	*	0425	B
5223	*	0510	B
5223	*	0595	B
5223	*	0680	B
5223	*	0765	B
5223	*	0850	B
5223	*	0935	B
5223	*	1020	B
5223	*	1105	B
5223	*	1190	B
5223	*	1275	B
5223	*	1360	B
5223	*	1445	B
5223	*	1530	B

Version C - With 2 Positioners

Series	Material	Width	Version
5223	*	0085	C
5223	*	0170	C
5223	*	0255	C
5223	*	0340	C
5223	*	0425	C
5223	*	0510	C
5223	*	0595	C
5223	*	0680	C
5223	*	0765	C
5223	*	0850	C
5223	*	0935	C
5223	*	1020	C
5223	*	1105	C
5223	*	1190	C
5223	*	1275	C
5223	*	1360	C
5223	*	1445	C
5223	*	1530	C

550 GT Side indent Tappeto Modulare 550 GT, H=8,7 M=85 Modular Belt Series 550 GT, H=8,7 M=85 / Modulare Mattenkette 550 GT, H=8,7 M=85

Metric Size

CODE STRUCTURE GUIDE			
(Example)			
5225	02	0595	B
Series	*Material	Width	Version

Backflex radius min.: 30 mm

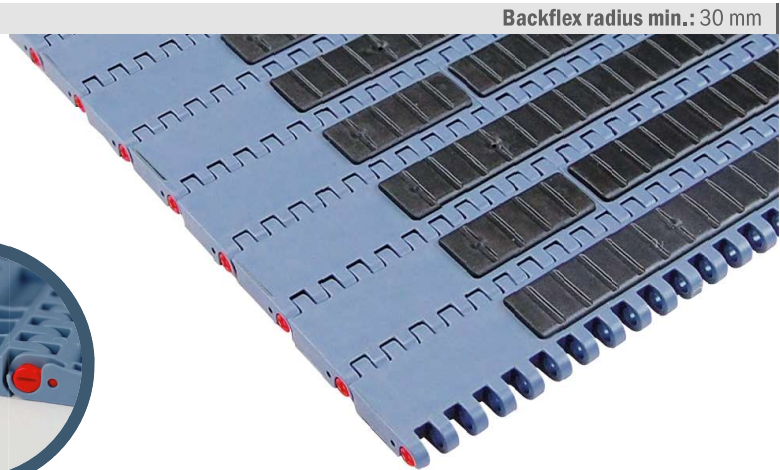
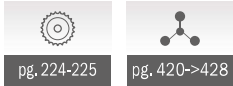

*Material

LFA - Code 01

Low friction Acetal

Max w. load: 27500 N/m
Weight: 9,8 kg/m²
Temp. range: dry -40÷80 °C
wet -40÷65 °C
Pin material: PBT white
Hardness of
Grip top Rubber: 75 Sha

PP - Code 02

Polypropylene

Max w. load: 16500 N/m
Weight: 8,2 kg/m²
Temp. range: dry 4÷80 °C
wet 4÷65 °C
Pin material: PP blu
Hardness of
Grip top Rubber: 75 Sha

MX - Code 03

Performance PBT

Max w. load: 21500 N/m
Weight: 10,3 kg/m²
Temp. range: dry -40÷120 °C
wet -40÷60 °C
Pin material: POM grey
Hardness of
Grip top Rubber: 75 Sha

Version A - Standard

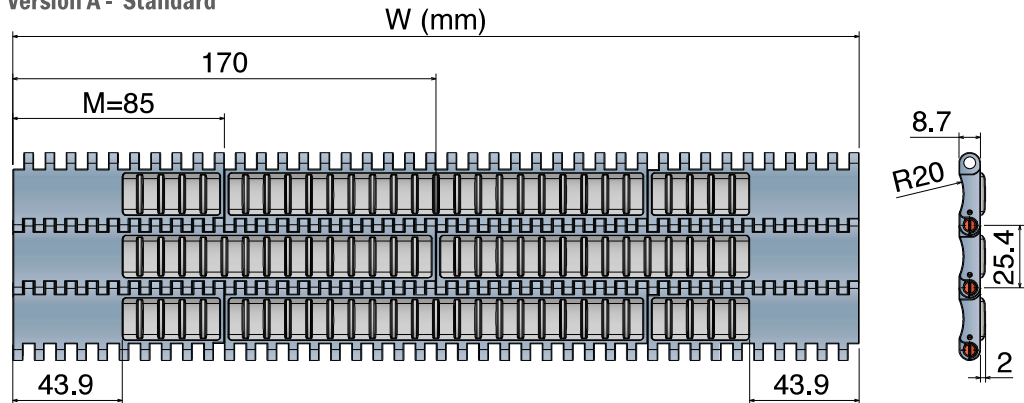

Version B - With 1 Positioner

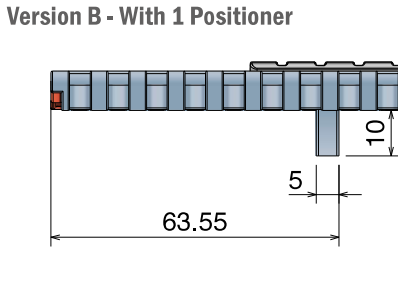

Version C - With 2 Positioners

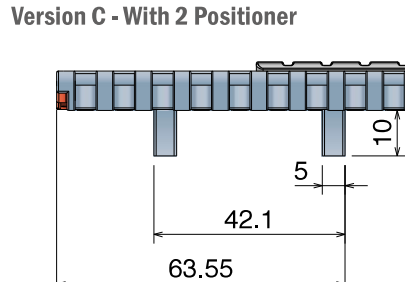

Version A - Standard

Series	Material	Width	Version
5225	*	0255	A
5225	*	0340	A
5225	*	0425	A
5225	*	0510	A
5225	*	0595	A
5225	*	0680	A
5225	*	0765	A
5225	*	0850	A
5225	*	0935	A
5225	*	1020	A
5225	*	1105	A
5225	*	1190	A
5225	*	1275	A
5225	*	1360	A
5225	*	1445	A
5225	*	1530	A

Version B - With 1 Positioner

Series	Material	Width	Version
5225	*	0255	B
5225	*	0340	B
5225	*	0425	B
5225	*	0510	B
5225	*	0595	B
5225	*	0680	B
5225	*	0765	B
5225	*	0850	B
5225	*	0935	B
5225	*	1020	B
5225	*	1105	B
5225	*	1190	B
5225	*	1275	B
5225	*	1360	B
5225	*	1445	B
5225	*	1530	B

Version C - With 2 Positioners

Series	Material	Width	Version
5225	*	0255	C
5225	*	0340	C
5225	*	0425	C
5225	*	0510	C
5225	*	0595	C
5225	*	0680	C
5225	*	0765	C
5225	*	0850	C
5225	*	0935	C
5225	*	1020	C
5225	*	1105	C
5225	*	1190	C
5225	*	1275	C
5225	*	1360	C
5225	*	1445	C
5225	*	1530	C

551

Metric Size

Pitch 25,4 mm
H= 12,7 mm

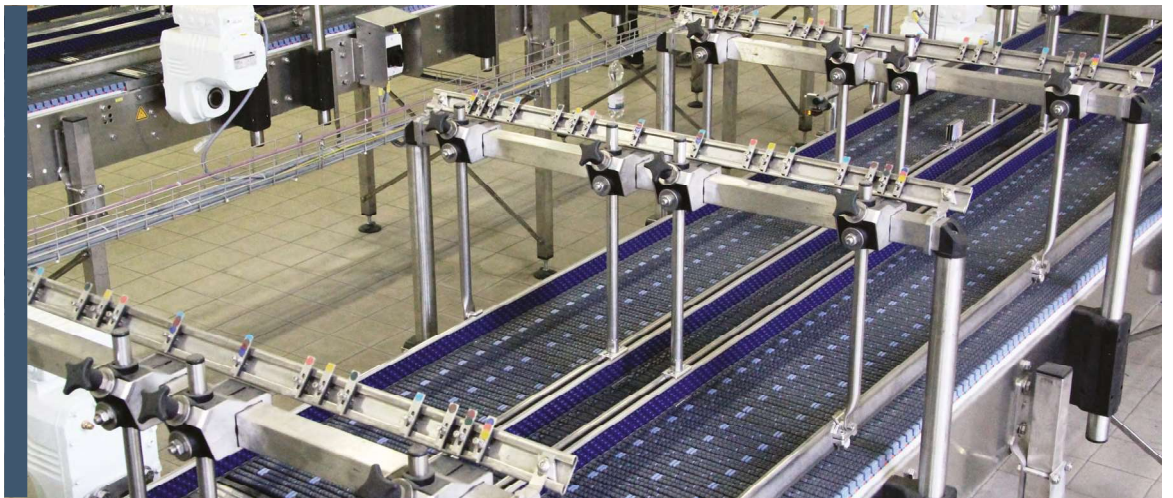

551 FT
551 FTT
551 GT
551 GT *Side indent*
551 LBP

551 FT

Tappeto Modulare 551 FT, H=12,7 M=85
 Modular Belt Series 551 FT, H=12,7 M=85 / Modulare Mattenkette 551 FT, H=12,7 M=85

Metric Size

CODE STRUCTURE GUIDE			
(Example)			
5231	01	0680	C
Series	*Material	Width	Version

Backflex radius min.: 25 mm

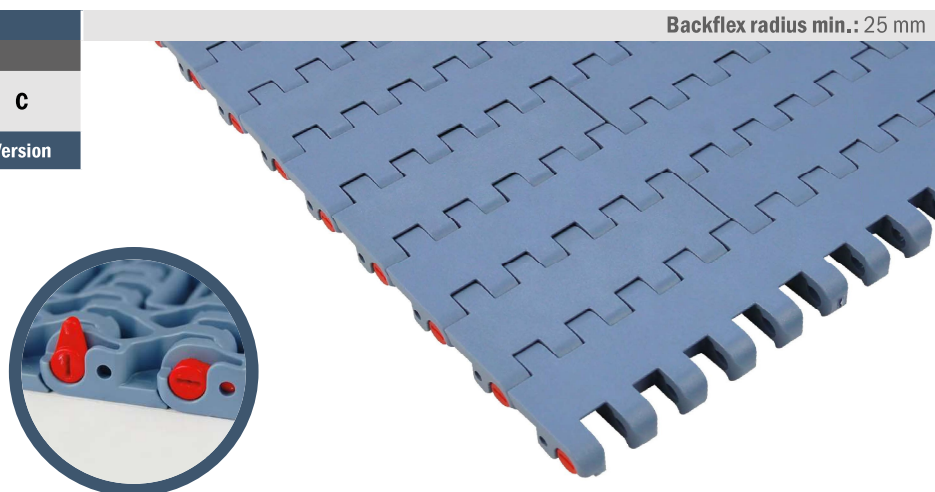

*Material

LFA - Code 01

Low friction Acetal

Max w. load: 41500 N/m
 Weight: 12,5 kg/m²
 Temp. range: dry -40÷80 °C
 wet -40÷65 °C
 Pin material: PBT white

MX - Code 03

Performance PBT

Max w. load: 33500 N/m
 Weight: 12,0 kg/m²
 Temp. range: dry -40÷120 °C
 wet -40÷60 °C
 Pin material: POM grey

MK - Code 08

Super Performance Acetal

Max w. load: 40000 N/m
 Weight: 12,5 kg/m²
 Temp. range: dry -40÷80 °C
 wet -40÷65 °C
 Pin material: PBT white

MPX - Code 25

Lubricated Acetal

Max w. load: 41500 N/m
 Weight: 12,5 kg/m²
 Temp. range: dry -40÷80 °C
 wet -40÷65 °C
 Pin material: PBT white

DKM - Code 16

Aramide Reinforced Acetal

Max w. load: 41500 N/m
 Weight: 12,5 kg/m²
 Temp. range: dry -40÷80 °C
 wet -40÷65 °C
 Pin material: PBT white

MWX - Code 17

Polyamide Composite

Max w. load: 41500 N/m
 Weight: 13,0 kg/m²
 Temp. range: dry -40÷104 °C
 wet NR
 Pin material: PBT white

Version A - Standard

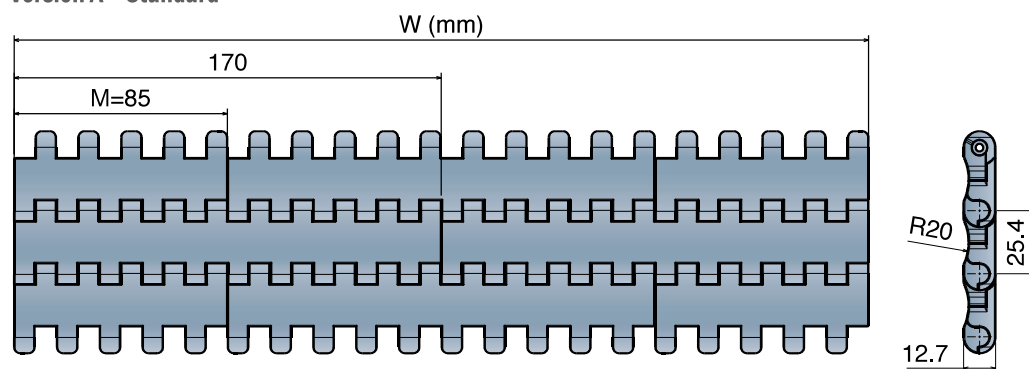

Version B - With 1 Positioner

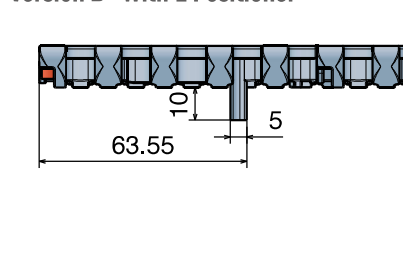

Version C - With 2 Positioners

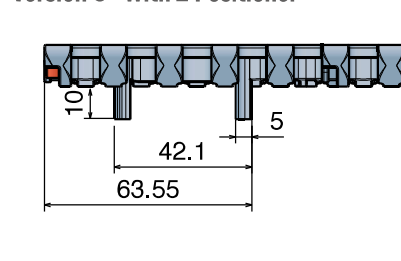

Version A - Standard

Series	Material	Width	Version
5231	*	0085	A
5231	*	0170	A
5231	*	0255	A
5231	*	0340	A
5231	*	0425	A
5231	*	0510	A
5231	*	0595	A
5231	*	0680	A
5231	*	0765	A
5231	*	0850	A
5231	*	0935	A
5231	*	1020	A
5231	*	1105	A
5231	*	1190	A
5231	*	1275	A
5231	*	1360	A
5231	*	1445	A
5231	*	1530	A

Version B - With 1 Positioner

Series	Material	Width	Version
5231	*	0085	B
5231	*	0170	B
5231	*	0255	B
5231	*	0340	B
5231	*	0425	B
5231	*	0510	B
5231	*	0595	B
5231	*	0680	B
5231	*	0765	B
5231	*	0850	B
5231	*	0935	B
5231	*	1020	B
5231	*	1105	B
5231	*	1190	B
5231	*	1275	B
5231	*	1360	B
5231	*	1445	B
5231	*	1530	B

Version C - With 2 Positioners

Series	Material	Width	Version
5231	*	0085	C
5231	*	0170	C
5231	*	0255	C
5231	*	0340	C
5231	*	0425	C
5231	*	0510	C
5231	*	0595	C
5231	*	0680	C
5231	*	0765	C
5231	*	0850	C
5231	*	0935	C
5231	*	1020	C
5231	*	1105	C
5231	*	1190	C
5231	*	1275	C
5231	*	1360	C
5231	*	1445	C
5231	*	1530	C

551 FTT

Tappeto Modulare 551 FTT, H=12,7 M=85
 Modular Belt Series 551 FTT, H=12,7 M=85 / Modulare Mattenkette 551 FTT, H=12,7 M=85

Metric Size

CODE STRUCTURE GUIDE			
(Example)			
5236	01	0255	C
Series	*Material	Width	Version

Backflex radius min.: 25 mm



pg. 226-227

pg. 420->428

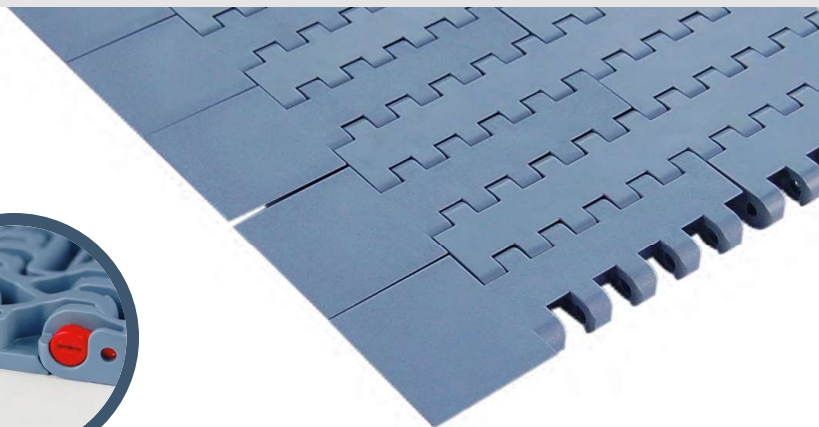

*Material

LFA - Code 01

Low friction Acetal

Max w. load: 41500 N/m
 Weight: 12,5 kg/m²
 Temp. range: dry -40÷80 °C
 wet -40÷65 °C
 Pin material: PBT white

MX - Code 03

Performance PBT

Max w. load: 33500 N/m
 Weight: 12,0 kg/m²
 Temp. range: dry -40÷120 °C
 wet -40÷60 °C
 Pin material: POM grey

MK - Code 08

Super Performance Acetal

Max w. load: 40000 N/m
 Weight: 12,5 kg/m²
 Temp. range: dry -40÷80 °C
 wet -40÷65 °C
 Pin material: PBT white

MPX - Code 25

Lubricated Acetal

Max w. load: 41500 N/m
 Weight: 12,5 kg/m²
 Temp. range: dry -40÷80 °C
 wet -40÷65 °C
 Pin material: PBT white

DKM - Code 16

Aramide Reinforced Acetal

Max w. load: 41500 N/m
 Weight: 12,5 kg/m²
 Temp. range: dry -40÷80 °C
 wet -40÷65 °C
 Pin material: PBT white

MWX - Code 17

Polyamide Composite

Max w. load: 41500 N/m
 Weight: 13,0 kg/m²
 Temp. range: dry -40÷104 °C
 wet NR
 Pin material: PBT white

Version C

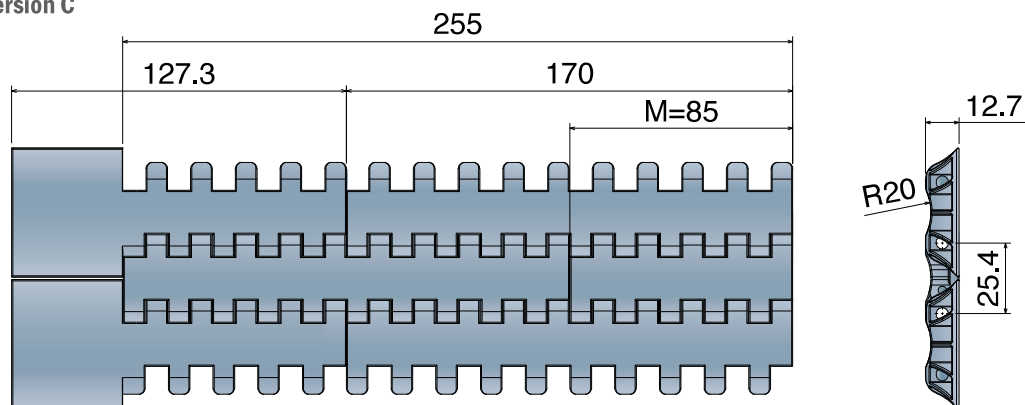

Version CN - Near

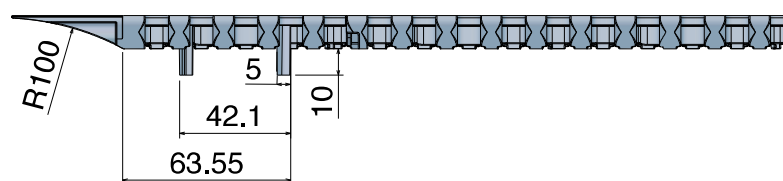

Version C0 - Opposite



Version C

Series	Material	Width	Version
5236	*	0085	C

Version CN - Near

Series	Material	Width	Version
5236	*	0170	CN
5236	*	0255	CN

Version C0 - Opposite

Series	Material	Width	Version
5236	*	0170	C0
5236	*	0255	C0

551 GT

Tappeto Modulare 551 GT, H=12,7 M=85
 Modular Belt Series 551 GT, H=12,7 M=85 / Modulare Mattenkette 551 GT, H=12,7 M=85

Metric Size

CODE STRUCTURE GUIDE			
(Example)			
5233	01	0255	B
Series	*Material	Width	Version

Backflex radius min.: 30 mm

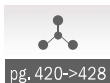
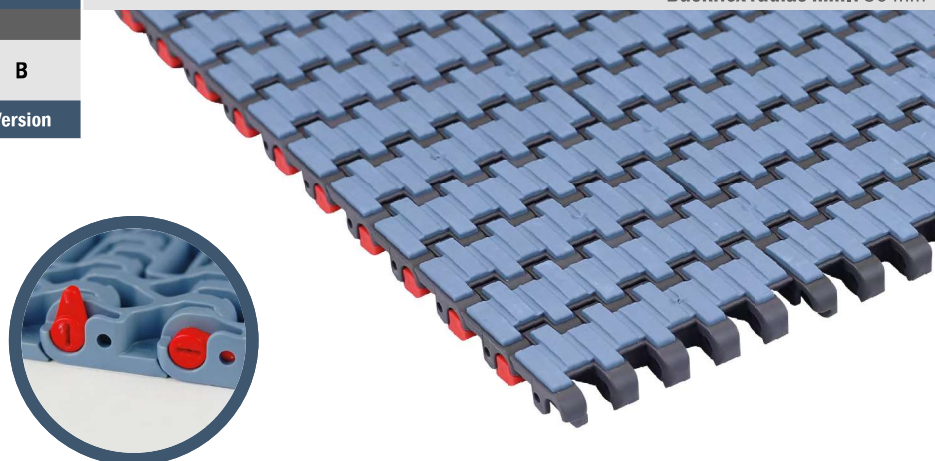

*Material

LFA - Code 01

Low friction Acetal

Max w. load: 41500 N/m
 Weight: 13,5 kg/m²
 Temp. range: dry -40÷80 °C
 wet -40÷65 °C
 Pin material: PBT white
 Hardness of
 Grip top Rubber: 75 Sha

PP - Code 02

Polypropylene

Max w. load: 27000 N/m
 Weight: 11,0 kg/m²
 Temp. range: dry 4÷80 °C
 wet 4÷65 °C
 Pin material: PP blu
 Hardness of
 Grip top Rubber: 75 Sha

MX - Code 03

Performance PBT

Max w. load: 33500 N/m
 Weight: 12,7 kg/m²
 Temp. range: dry -40÷120 °C
 wet -40÷60 °C
 Pin material: POM grey
 Hardness of
 Grip top Rubber: 75 Sha

Version A - Standard

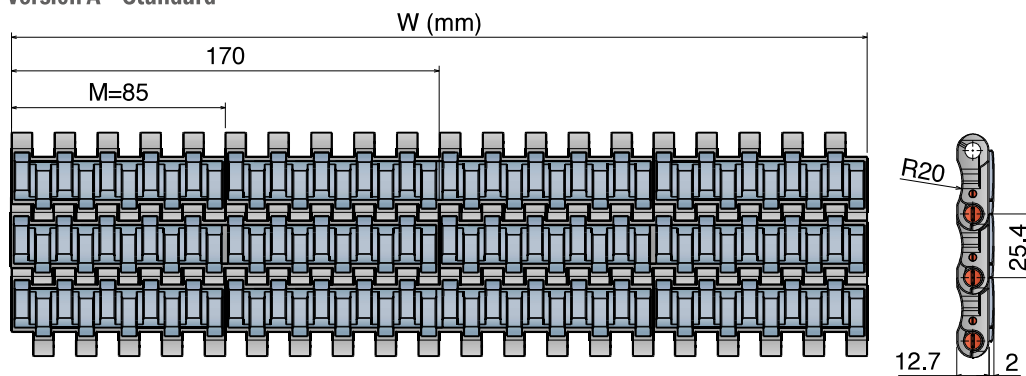

Version B - With 1 Positioner

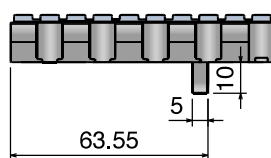

Version C - With 2 Positioner

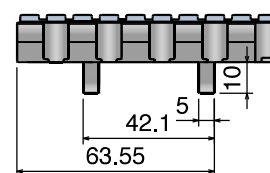

Version A - Standard

Series	Material	Width	Version
5233	*	0085	A
5233	*	0170	A
5233	*	0255	A
5233	*	0340	A
5233	*	0425	A
5233	*	0510	A
5233	*	0595	A
5233	*	0680	A
5233	*	0765	A
5233	*	0850	A
5233	*	0935	A
5233	*	1020	A
5233	*	1105	A
5233	*	1190	A
5233	*	1275	A
5233	*	1360	A
5233	*	1445	A
5233	*	1530	A

Version B - With 1 Positioner

Series	Material	Width	Version
5233	*	0085	B
5233	*	0170	B
5233	*	0255	B
5233	*	0340	B
5233	*	0425	B
5233	*	0510	B
5233	*	0595	B
5233	*	0680	B
5233	*	0765	B
5233	*	0850	B
5233	*	0935	B
5233	*	1020	B
5233	*	1105	B
5233	*	1190	B
5233	*	1275	B
5233	*	1360	B
5233	*	1445	B
5233	*	1530	B

Version C - With 2 Positioners

Series	Material	Width	Version
5233	*	0085	C
5233	*	0170	C
5233	*	0255	C
5233	*	0340	C
5233	*	0425	C
5233	*	0510	C
5233	*	0595	C
5233	*	0680	C
5233	*	0765	C
5233	*	0850	C
5233	*	0935	C
5233	*	1020	C
5233	*	1105	C
5233	*	1190	C
5233	*	1275	C
5233	*	1360	C
5233	*	1445	C
5233	*	1530	C

551 GT Side indent

Tappeti modulari / Modular belts / Mattenketten

551 GT Side indent

Tappeto Modulare 551 GT, H=12,7 M=85
Modular Belt Series 551 GT, H=12,7 M=85 / Modulare Mattenkette 551 GT, H=12,7 M=85

Metric Size

CODE STRUCTURE GUIDE			
(Example)			
5235	02	0765	A
Series	*Material	Width	Version

Backflex radius min.: 30 mm



pg. 226-227

pg. 420->428

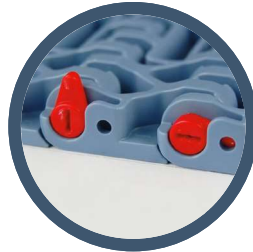

*Material

LFA - Code 01

Low friction Acetal

Max w. load: 41500 N/m
Weight: 13,2 kg/m²
Temp. range: dry -40+80 °C
wet -40+65 °C

Pin material: PBT white
Hardness of
Grip top Rubber: 75 ShA

PP - Code 02

Polypropylene

Max w. load: 27000 N/m
Weight: 10,8 kg/m²
Temp. range: dry 4+80 °C
wet 4+65 °C

Pin material: PP blu
Hardness of
Grip top Rubber: 75 ShA

MX - Code 03

Performance PBT

Max w. load: 33500 N/m
Weight: 12,5 kg/m²
Temp. range: dry -40+120 °C
wet -40+60 °C

Pin material: POM grey
Hardness of
Grip top Rubber: 75 ShA

Version A - Standard

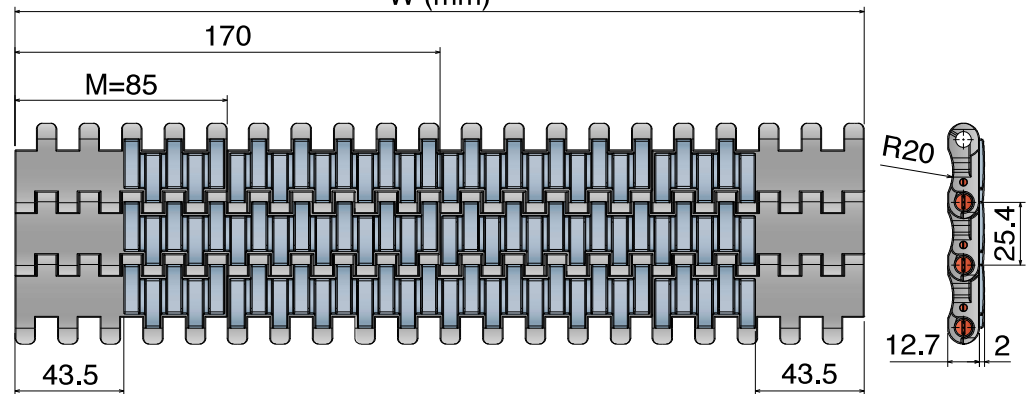

Version B - With 1 Positioner

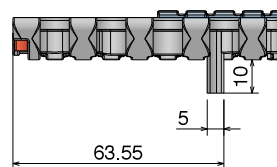

Version C - With 2 Positioner

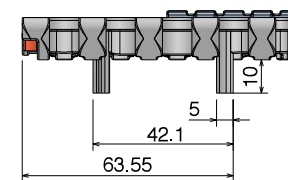

Version A - Standard

Series	Material	Width	Version
5235	*	0255	A
5235	*	0340	A
5235	*	0425	A
5235	*	0510	A
5235	*	0595	A
5235	*	0680	A
5235	*	0765	A
5235	*	0850	A
5235	*	0935	A
5235	*	1020	A
5235	*	1105	A
5235	*	1190	A
5235	*	1275	A
5235	*	1360	A
5235	*	1445	A
5235	*	1530	A

Version B - With 1 Positioner

Series	Material	Width	Version
5235	*	0255	B
5235	*	0340	B
5235	*	0425	B
5235	*	0510	B
5235	*	0595	B
5235	*	0680	B
5235	*	0765	B
5235	*	0850	B
5235	*	0935	B
5235	*	1020	B
5235	*	1105	B
5235	*	1190	B
5235	*	1275	B
5235	*	1360	B
5235	*	1445	B
5235	*	1530	B

Version C - With 2 Positioners

Series	Material	Width	Version
5235	*	0255	C
5235	*	0340	C
5235	*	0425	C
5235	*	0510	C
5235	*	0595	C
5235	*	0680	C
5235	*	0765	C
5235	*	0850	C
5235	*	0935	C
5235	*	1020	C
5235	*	1105	C
5235	*	1190	C
5235	*	1275	C
5235	*	1360	C
5235	*	1445	C
5235	*	1530	C

551 LBP

Tappeto Modulare 551 LBP, H=12,7 M=85
 Modular Belt Series 551 LBP, H=12,7 M=85 / Modulare Mattenkette 551 LBP, H=12,7 M=85

Metric Size

CODE STRUCTURE GUIDE			
(Example)			
5234	01	0425	A
Series	*Material	Width	Version

Backflex radius min.: 120 mm

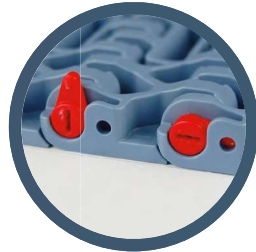
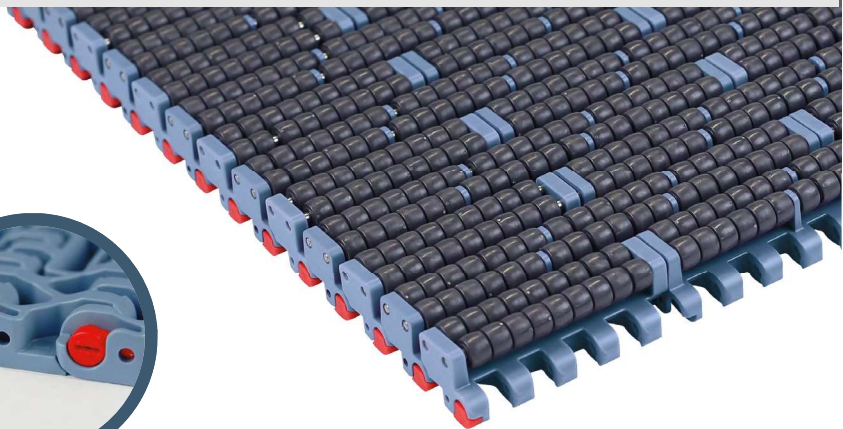

*Material

LFA - Code 01
 Low friction Acetal

Max w. load: 41500 N/m
Weight: 26,9 kg/m²
Temp. range: dry -40÷80 °C
 wet 1÷65 °C
Pin material: PBT white

Version A - Standard

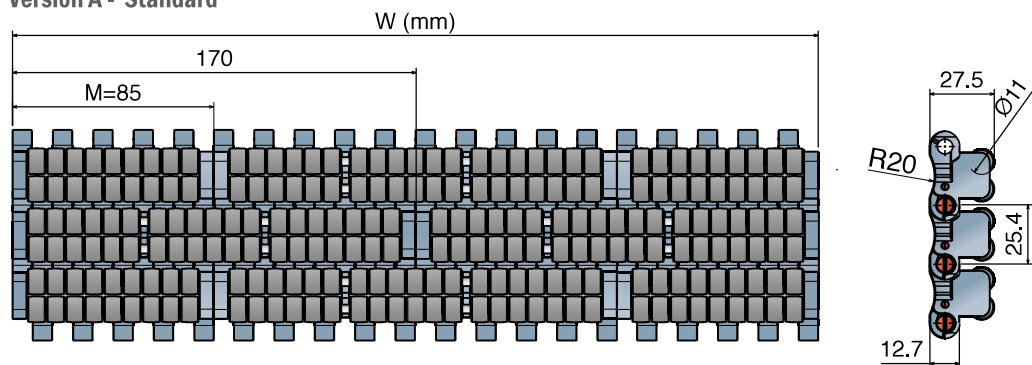

Version B - With 1 Positioner

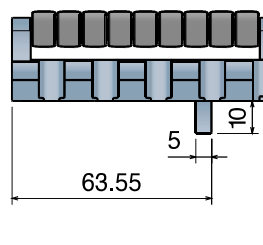

Version C - With 2 Positioners

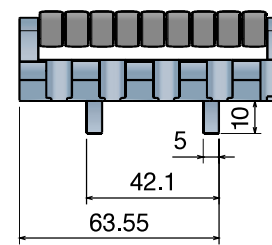

Version A - Standard

Series	Material	Width	Version
5234	*	0085	A
5234	*	0170	A
5234	*	0255	A
5234	*	0340	A
5234	*	0425	A
5234	*	0510	A
5234	*	0595	A
5234	*	0680	A
5234	*	0765	A
5234	*	0850	A
5234	*	0935	A
5234	*	1020	A
5234	*	1105	A
5234	*	1190	A
5234	*	1275	A
5234	*	1360	A
5234	*	1445	A
5234	*	1530	A

Version B - With 1 Positioner

Series	Material	Width	Version
5234	*	0085	B
5234	*	0170	B
5234	*	0255	B
5234	*	0340	B
5234	*	0425	B
5234	*	0510	B
5234	*	0595	B
5234	*	0680	B
5234	*	0765	B
5234	*	0850	B
5234	*	0935	B
5234	*	1020	B
5234	*	1105	B
5234	*	1190	B
5234	*	1275	B
5234	*	1360	B
5234	*	1445	B
5234	*	1530	B

Version C - With 2 Positioners

Series	Material	Width	Version
5234	*	0085	C
5234	*	0170	C
5234	*	0255	C
5234	*	0340	C
5234	*	0425	C
5234	*	0510	C
5234	*	0595	C
5234	*	0680	C
5234	*	0765	C
5234	*	0850	C
5234	*	0935	C
5234	*	1020	C
5234	*	1105	C
5234	*	1190	C
5234	*	1275	C
5234	*	1360	C
5234	*	1445	C
5234	*	1530	C

552

Imperial Size

Pitch 25,4 mm
H= 12,7 mm



552 FT
552 FT *One track Belt*
552 FTT

552 FT

Tappeto Modulare 552 FT, H=12,7 M=3"
Modular Belt Series 552 FT, H=12,7 M=3" / Modulare Mattenkette 552 FT, H=12,7 M=3"

Imperial Size

CODE STRUCTURE GUIDE			
(Example)			
5341	01	0021	A
Series	*Material	Width	Version

Backflex radius min.: 25 mm



pg. 228-229



pg. 420->428

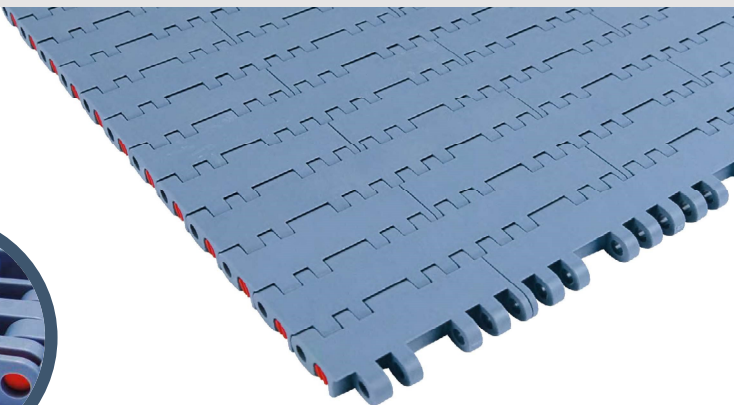

*Material

LFA - Code 01

Low friction Acetal

Max w. load: 41500 N/m
Weight: 13,5 kg/m²
Temp. range: dry -40÷80 °C
wet -40÷65 °C
Pin material: PBT white

MX - Code 03

Performance PBT

Max w. load: 33500 N/m
Weight: 13,0 kg/m²
Temp. range: dry -40÷120 °C
wet -40÷60 °C
Pin material: POM grey

MK - Code 08

Super Performance Acetal

Max w. load: 40000 N/m
Weight: 13,5 kg/m²
Temp. range: dry -40÷80 °C
wet -40÷65 °C
Pin material: PBT white

MPX - Code 25

Lubricated Acetal

Max w. load: 41500 N/m
Weight: 13,5 kg/m²
Temp. range: dry -40÷80 °C
wet -40÷65 °C
Pin material: PBT white

DKM - Code 16

Aramide Reinforced Acetal

Max w. load: 41500 N/m
Weight: 13,5 kg/m²
Temp. range: dry -40÷80 °C
wet -40÷65 °C
Pin material: PBT white

MWX - Code 17

Polyamide Composite

Max w. load: 41500 N/m
Weight: 14,0 kg/m²
Temp. range: dry -40÷104 °C
wet NR
Pin material: PBT white

Version A - Standard

W (inch)

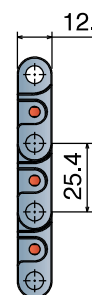
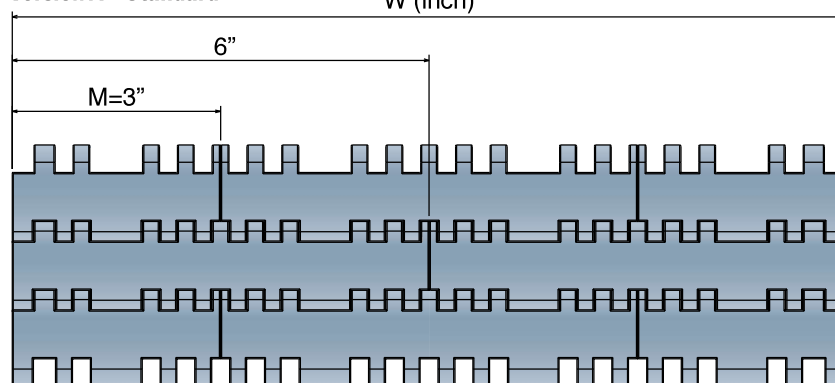

Version A - Standard

Series	Material	Width	Version
5341	*	0009	A
5341	*	0012	A
5341	*	0015	A
5341	*	0018	A
5341	*	0021	A
5341	*	0024	A
5341	*	0027	A
5341	*	0030	A
5341	*	0033	A
5341	*	0036	A
5341	*	0039	A
5341	*	0042	A
5341	*	0045	A
5341	*	0048	A
5341	*	0051	A
5341	*	0054	A

552 FT One track Belt

Tappeti modulari / Modular belts / Mattenketten

552 FT One track Belt

Tappeto Modulare 552 FT, H=12,7
Modular Belt Series 550 FT, H=12,7 / Modulare Mattenkette 552 FT, H=12,7

Imperial Size

CODE STRUCTURE GUIDE			
(Example)			
5341	01	0003	A
Series	*Material	Width	Version

Backflex radius min.: 25 mm

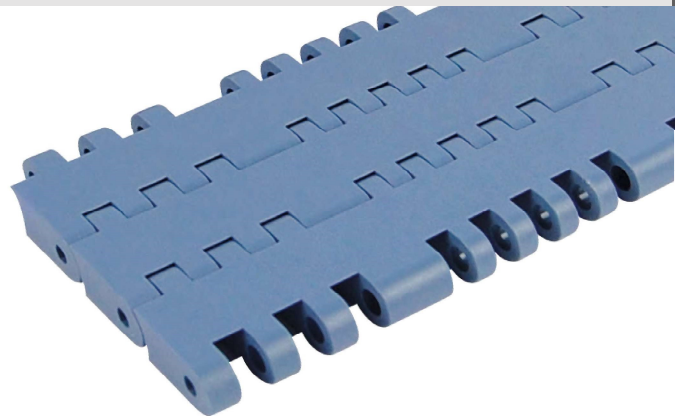
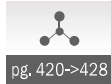

*Material

LFA - Code 01

Low friction Acetal

Max w. load: 41500 N/m
Weight: 13,5 kg/m²
Temp. range: dry -40÷80 °C
wet -40÷65 °C
Pin material: PBT white

MX - Code 03

Performance PBT

Max w. load: 33500 N/m
Weight: 13,0 kg/m²
Temp. range: dry -40÷120 °C
wet -40÷60 °C
Pin material: POM grey

MK - Code 08

Super Performance Acetal

Max w. load: 40000 N/m
Weight: 13,5 kg/m²
Temp. range: dry -40÷80 °C
wet -40÷65 °C
Pin material: PBT white

MPX - Code 25

Lubricated Acetal

Max w. load: 41500 N/m
Weight: 13,5 kg/m²
Temp. range: dry -40÷80 °C
wet -40÷65 °C
Pin material: PBT white

DKM - Code 16

Aramide Reinforced Acetal

Max w. load: 41500 N/m
Weight: 13,5 kg/m²
Temp. range: dry -40÷80 °C
wet -40÷65 °C
Pin material: PBT white

MWX - Code 17

Polyamide Composite

Max w. load: 41500 N/m
Weight: 134,0 kg/m²
Temp. range: dry -40÷104 °C
wet NR
Pin material: PBT white

Version A - Standard

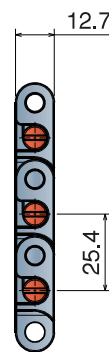
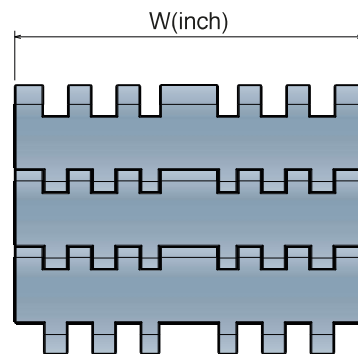

Version C - With 2 Positioner

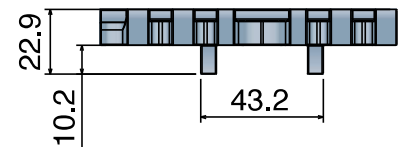

Version A/C

One track belt

Series	Material	Width	Version
5341	*	0003	A
5341	*	0006	A
5341	*	0003	C
5341	*	0006	C

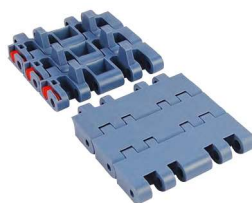

K325 - One track belt

Series	Material	Width	Version
5341	*	9325	A
5341	*	9325	C

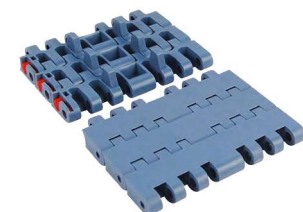

K450 - One track belt

Series	Material	Width	Version
5341	*	9450	A
5341	*	9450	C

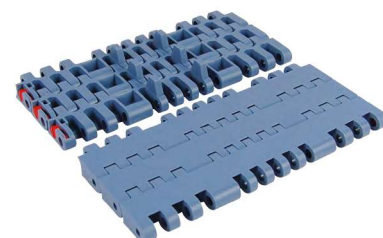

K750 - One track belt

Series	Material	Width	Version
5341	*	9750	A
5341	*	9750	C

552 FTT

Tappeto Modulare 552 FTT, H=12,7
 Modular Belt Series 552 FTT, H=12,7 / Modulare Mattenkette 552 FTT, H=12,7

Imperial Size

CODE STRUCTURE GUIDE			
(Example)			
5346	01	9450	C-R
Series	*Material	Width	Version

Backflex radius min.: 25 mm

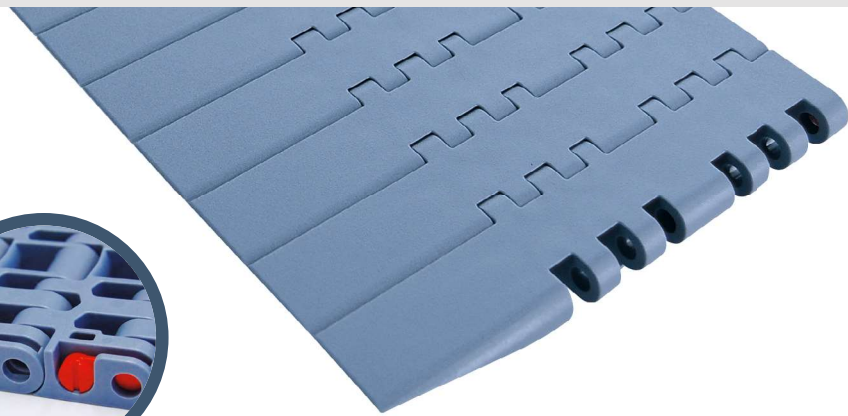
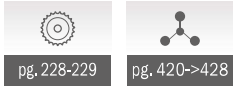

*Material

LFA - Code 01

Low friction Acetal

Max w. load: 41500 N/m
 Weight: 13,5 kg/m²
 Temp. range: dry -40÷80 °C
 wet -40÷65 °C
 Pin material: PBT white

MX - Code 03

Performance PBT

Max w. load: 33500 N/m
 Weight: 13,0 kg/m²
 Temp. range: dry -40÷120 °C
 wet -40÷60 °C
 Pin material: POM grey

MK - Code 08

Super Performance Acetal

Max w. load: 40000 N/m
 Weight: 13,5 kg/m²
 Temp. range: dry -40÷80 °C
 wet -40÷65 °C
 Pin material: PBT white

MPX - Code 25

Lubricated Acetal

Max w. load: 41500 N/m
 Weight: 13,5 kg/m²
 Temp. range: dry -40÷80 °C
 wet -40÷65 °C
 Pin material: PBT white

DKM - Code 16

Aramide Reinforced Acetal

Max w. load: 41500 N/m
 Weight: 13,5 kg/m²
 Temp. range: dry -40÷80 °C
 wet -40÷65 °C
 Pin material: PBT white

MWX - Code 17

Polyamide Composite

Max w. load: 41500 N/m
 Weight: 14,0 kg/m²
 Temp. range: dry -40÷104 °C
 wet NR
 Pin material: PBT white

552 FTT - DX Version

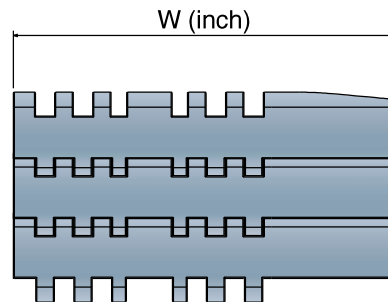
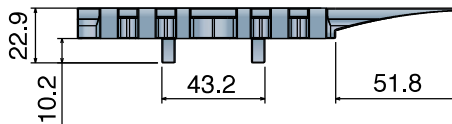

Direction of travel

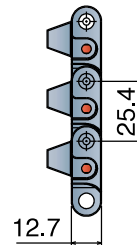

K450 / K750

Series	Material	Width	Version
5346	*	9450	C-R
5346	*	9750	C-R

552 FTT - SX Version

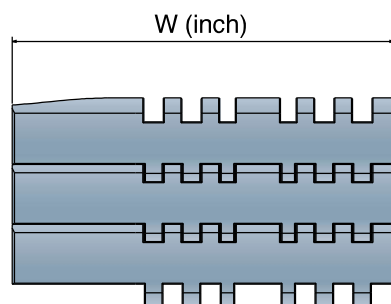
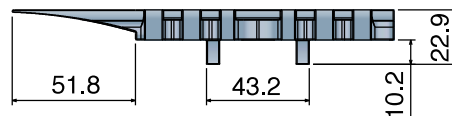

Direction of travel

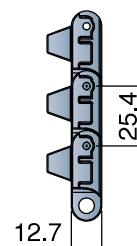

K450 / K750

Series	Material	Width	Version
5346	*	9450	C-L
5346	*	9750	C-L

556

Imperial Size

Pitch 25,4 mm
H= 12,7 mm

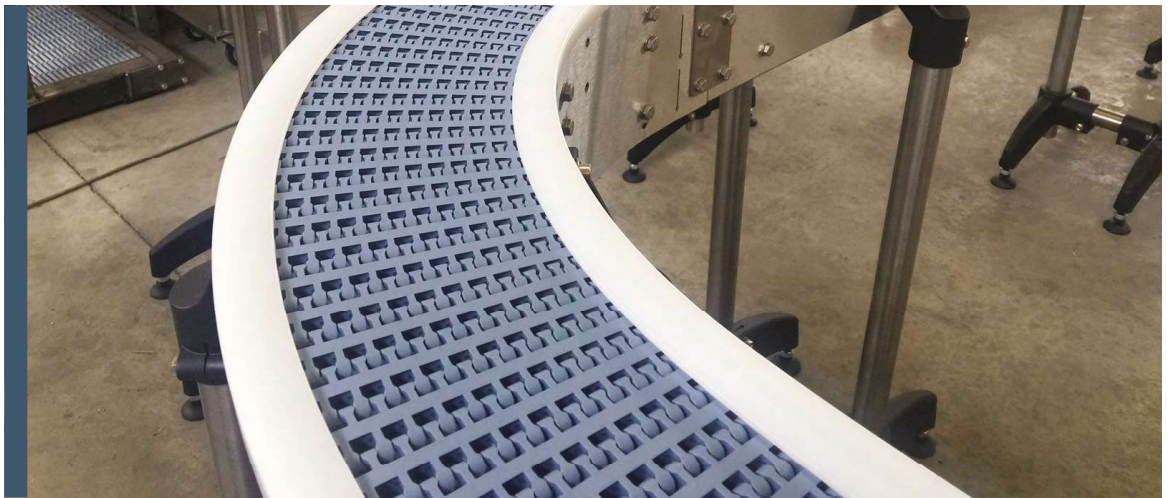

556 FT
556 GT

556 FT

Tappeto Modulare Curvilineo Serie 556, H=12,7 M=3"
Side Flex Modular Belt Series 556, H=12,7 M=3" / Kurvengängige Mattenkette Serie 556, H=12,7 M=3"

Imperial Size

CODE STRUCTURE GUIDE			
(Example)			
5431	01	0048	C
Series	*Material	Width	Version

Backflex radius min.: 25 mm

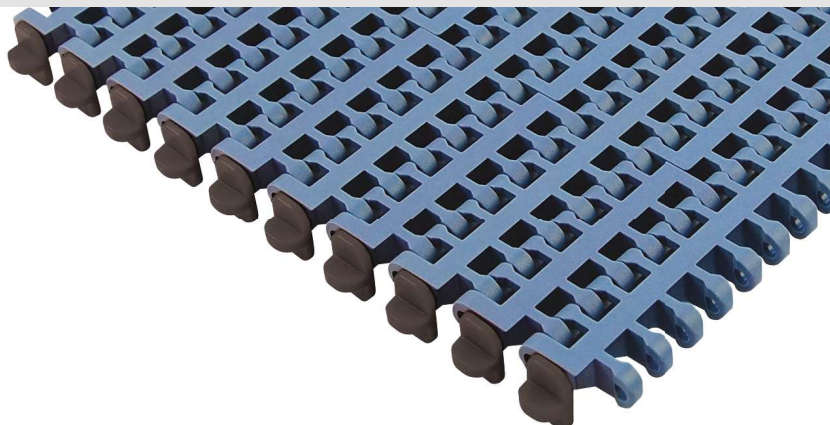

pg. 232-233

pg. 420->428

*Material

LFA - Code 01

Low friction Acetal

Max w. load:

Straight: 30000 N/m
Curve 2000 N

Weight: 7,5 kg/m²

Temp. range: dry -40+80 °C
wet -40+65 °C

Pin material: PBT white

MX - Code 03

Performance PBT

Max w. load:

Straight: 24000 N/m
Curve 1500 N

Weight: 7,2 kg/m²

Temp. range: dry -40+120 °C
wet -40+60 °C

Pin material: POM grey

MK - Code 08

Super Performance Acetal

Max w. load:

Straight: 28800 N/m
Curve 1900 N

Weight: 7,7 kg/m²

Temp. range: dry -40+80 °C
wet -40+65 °C

Pin material: PBT white

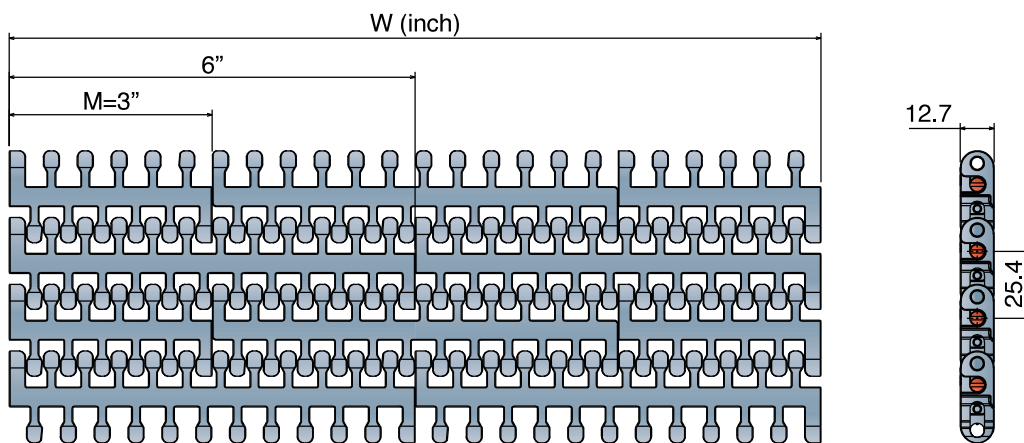

MPX - Code 25

Lubricated Acetal

Max w. load:

Straight: 30000 N/m
Curve 2000 N

Weight: 7,5 kg/m²

Temp. range: dry -40+80 °C
wet -40+65 °C

Pin material: PBT white

DKM - Code 16

Aramide Reinforced Acetal

Max w. load:

Straight: 30000 N/m
Curve 2000 N

Weight: 7,5 kg/m²

Temp. range: dry -40+80 °C
wet -40+65 °C

Pin material: PBT white

MWX - Code 17

Polyamide Composite

Max w. load:

Straight: 30000 N/m
Curve 2000 N

Weight: 7,5 kg/m²

Temp. range: dry -40+104 °C
wet NR

Pin material: PBT white

STANDARD

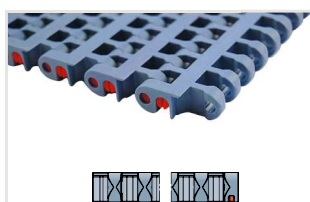

Series	Material	Width	Version	min radius
5431	*	0009	A	435
5431	*	0012	A	580
5431	*	0015	A	725
5431	*	0018	A	890
5431	*	0021	A	1040
5431	*	0024	A	1250

ONE TRACK BELT

Series	Material	Width	Version	min radius
5431	*	0003	A	145
5431	*	0006	A	290

TAB

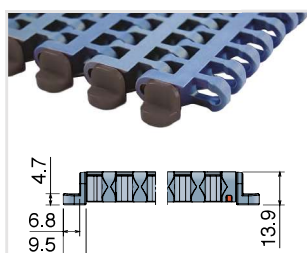

Series	Material	Width	Version	min radius
5431	*	0006	B	290
5431	*	0009	B	435
5431	*	0012	B	580
5431	*	0015	B	725
5431	*	0018	B	890
5431	*	0021	B	1040
5431	*	0024	B	1250

TAB/POSITIONER

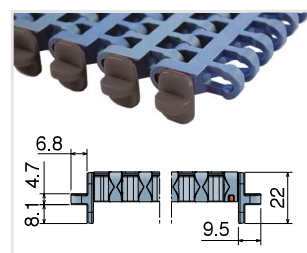

Series	Material	Width	Version	min radius
5431	*	0006	C	290
5431	*	0009	C	435
5431	*	0012	C	580
5431	*	0015	C	725
5431	*	0018	C	890
5431	*	0021	C	1040
5431	*	0024	C	1250

556 GT

Tappeti modulari / Modular belts / Mattenketten

556 GT

Tappeto Modulare Curvilineo Serie 556 GT, H=12,7 M=3"

Side Flex Modular Belt Series 556 GT, H=12,7 M=3" / Kurvengängige Mattenkette Serie 556 GT, H=12,7 M=3"

Imperial Size

CODE STRUCTURE GUIDE			
(Example)			
5433	02	0018	B
Series	*Material	Width	Version

Backflex radius min.: 25 mm



pg. 232-233

pg. 420->428

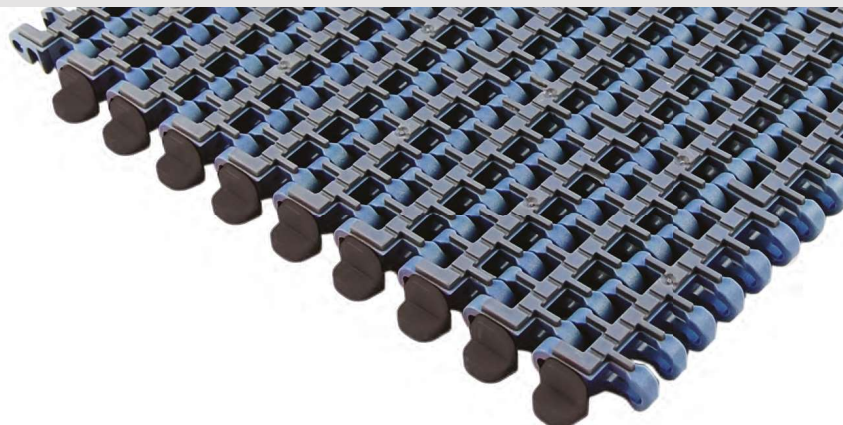

*Material

LFA - Code 01

Low friction Acetal

Max w. load:

Straight: 30000 N/m

Curve: 2000 N

Weight: 7,7 kg/m²

Temp. range: dry -40+80 °C

wet -40+65 °C

Pin material: PBT white

Hardness of

Grip top Rubber: 75 ShA

PPB - Code 24

Polypropylene

Standard rubber: 50 ShA

Code: -S

Max w. load:

Straight: 19500 N/m

Curve: 1300 N

Weight: 6,0 kg/m²

Temp. range: dry 4+65 °C

wet 4+65 °C

Pin material: PP blu

Hardness of

Grip top Rubber: 50 ShA

MX - Code 03

Performance PBT

Max w. load:

Straight: 28800 N/m

Curve: 1500 N

Weight: 7,8 kg/m²

Temp. range: dry -40+120 °C

wet -40+60 °C

Pin material: POM grey

Hardness of

Grip top Rubber: 75 ShA

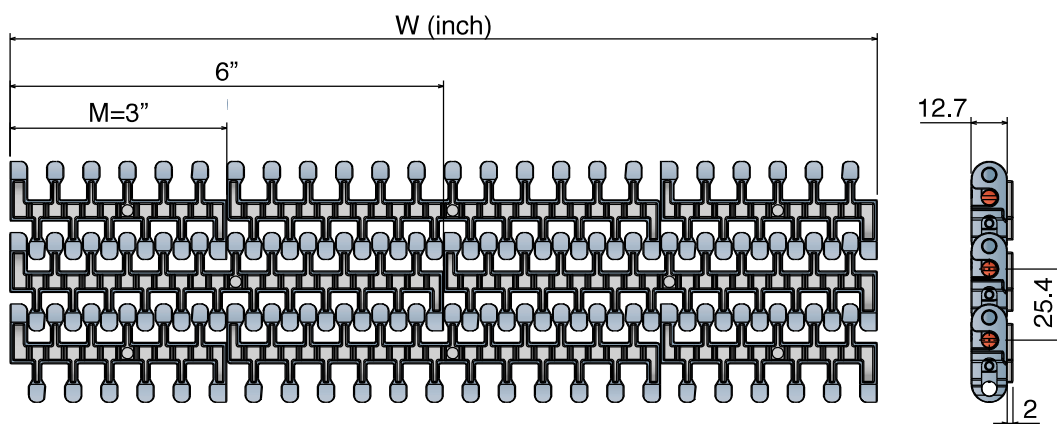

STANDARD



Series	Material	Width	Version	min radius
5433	*	0009	A	435
5433	*	0012	A	580
5433	*	0015	A	725
5433	*	0018	A	890
5433	*	0021	A	1040
5433	*	0024	A	1250

ONE TRACK BELT

Series	Material	Width	Version	min radius
5433	*	0003	A	145
5433	*	0006	A	290

TAB



Series	Material	Width	Version	min radius
5433	*	0006	B	290
5433	*	0009	B	435
5433	*	0012	B	580
5433	*	0015	B	725
5433	*	0018	B	890
5433	*	0021	B	1040
5433	*	0024	B	1250

TAB/POSITIONER



Series	Material	Width	Version	min radius
5433	*	0006	C	290
5433	*	0009	C	435
5433	*	0012	C	580
5433	*	0015	C	725
5433	*	0018	C	890
5433	*	0021	C	1040
5433	*	0024	C	1250

600

Metric Size

Pitch 31,75 mm
H= 12,7 mm

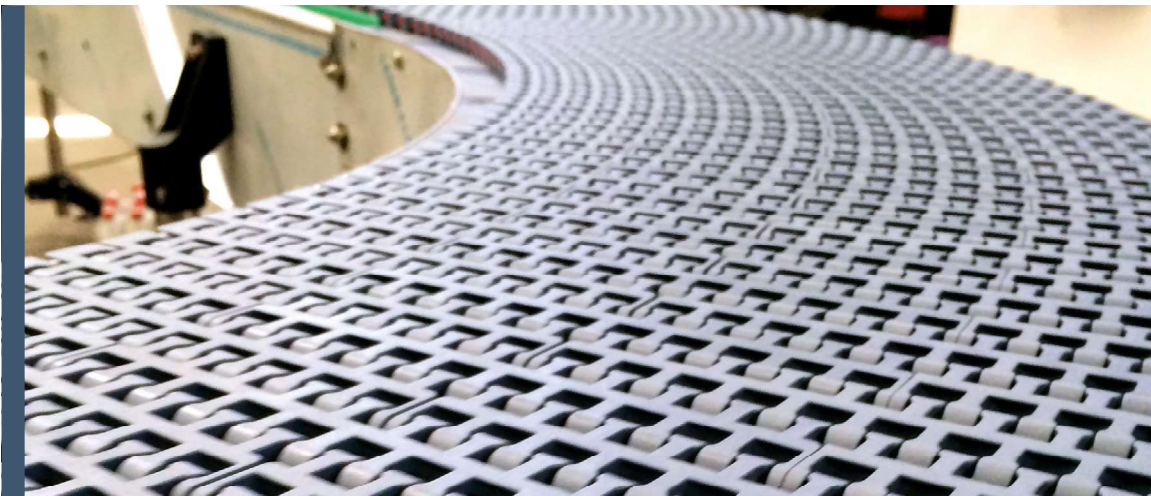

600 Standard

1047 Heavy duty profile

600 Heavy duty

600 Small radius

600 Heavy duty /Small radius

600 with pusher

600 Standard

Tappeto Modulare Curvilineo Serie 600, H=12,7 M=85
Side Flex Modular Belt Series 600, H=12,7 M=85 / Kurvengängige Mattenkette Serie 600, H=12,7 M=85

Metric Size

CODE STRUCTURE GUIDE

(Example)

5421	03	0595	A
Series	*Material	Width	Version

Backflex radius min.: 25 mm

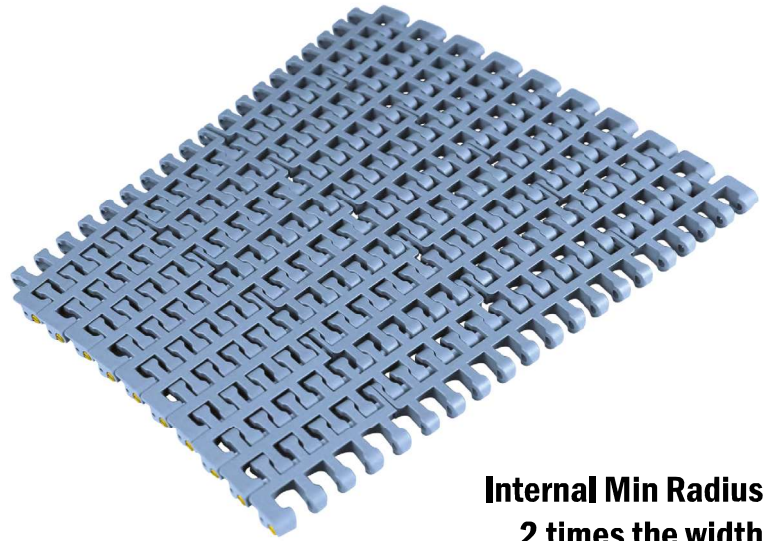
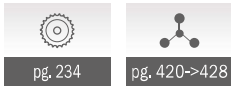

Internal Min Radius
2 times the width

*Material

LFA - Code 01

Low friction Acetal

Max w. load:
Straight 30000 N/m
Curve 2500 N
Weight: 7,7 kg/m²
Temp. range: dry -40+80 °C
wet -40+65 °C
Pin material: PBT white

MX - Code 03

Performance PBT

Max w. load:
Straight 24000 N/m
Curve 2000 N
Weight: 7,5 kg/m²
Temp. range: dry -40+120 °C
wet -40+60 °C
Pin material: POM grey

MK - Code 08

Super Performance Acetal

Max w. load:
Straight 28800 N/m
Curve 2400 N
Weight: 7,7 kg/m²
Temp. range: dry -40+80 °C
wet -40+65 °C
Pin material: PBT white

MPX - Code 25

Lubricated Acetal

Max w. load:
Straight 30000 N/m
Curve 2500 N
Weight: 7,7 kg/m²
Temp. range: dry -40+80 °C
wet -40+65 °C
Pin material: PBT white

DKM - Code 16

Aramid Reinforced Acetal

Max w. load:
Straight 30000 N/m
Curve 2500 N
Weight: 7,7 kg/m²
Temp. range: dry -40+80 °C
wet -40+65 °C
Pin material: PBT white

MWX - Code 17

Polyamide Composite

Max w. load:
Straight 30000 N/m
Curve 2500 N
Weight: 8,0 kg/m²
Temp. range: dry -40+104 °C
wet NR
Pin material: PBT white

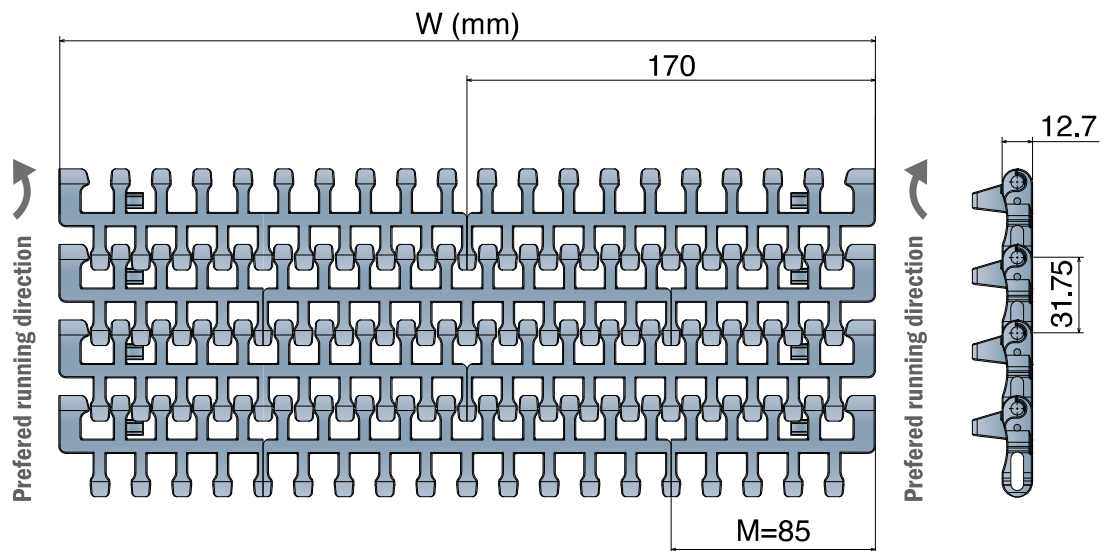

STANDARD					TAB					REVERSE TAB					TAB REVERSE TAB				
Series	Material	Width	Version	min radius	Series	Material	Width	Version	min radius	Series	Material	Width	Version	min radius	Series	Material	Width	Version	min radius
5421	*	0255	A	510	5421	*	0255	B	510	5421	*	0255	C	510	5421	*	0255	D	510
5421	*	0340	A	680	5421	*	0340	B	680	5421	*	0340	C	680	5421	*	0340	D	680
5421	*	0425	A	850	5421	*	0425	B	850	5421	*	0425	C	850	5421	*	0425	D	850
5421	*	0510	A	1020	5421	*	0510	B	1020	5421	*	0510	C	1020	5421	*	0510	D	1020
5421	*	0595	A	1190	5421	*	0595	B	1190	5421	*	0595	C	1190	5421	*	0595	D	1190
5421	*	0680	A	1360	5421	*	0680	B	1360	5421	*	0680	C	1360	5421	*	0680	D	1360
5421	*	0765	A	1530	5421	*	0765	B	1530	5421	*	0765	C	1530	5421	*	0765	D	1530
5421	*	0850	A	1700	5421	*	0850	B	1700	5421	*	0850	C	1700	5421	*	0850	D	1700

600 Heavy duty

Tappeto Modulare Curvilineo Serie 600, H=12,7 M=85
Side Flex Modular Belt Series 600, H=12,7 M=85 / Kurvengängige Mattenkette Serie 600, H=12,7 M=85

CODE STRUCTURE GUIDE

(Example)

Backflex radius min.: 25 mm

5422	03	0340	E
Series	*Material	Width	Version



pg. 234

pg. 420->428

* Material

LFA - Code 01

Low friction Acetal

Max w. load:
Straight 30000 N/m
Curve 3500 N
Weight: 8,3 kg/m²
Temp. range: dry -40÷80 °C
wet -40÷65 °C
Pin material: PBT white

MX - Code 03

Performance PBT

Max w. load:
Straight 24000 N/m
Curve 3000 N
Weight: 8,0 kg/m²
Temp. range: dry -40÷120 °C
wet -40÷60 °C
Pin material: POM grey

MK - Code 08

Super Performance Acetal

Max w. load:
Straight 28800 N/m
Curve 3350 N
Weight: 8,3 kg/m²
Temp. range: dry -40÷80 °C
wet -40÷65 °C
Pin material: PBT white

MPX - Code 25

Lubricated Acetal

Max w. load:
Straight 30000 N/m
Curve 3500 N
Weight: 8,3 kg/m²
Temp. range: dry -40÷80 °C
wet -40÷65 °C
Pin material: PBT white

DKM - Code 16

Aramide Reinforced Acetal

Max w. load:
Straight 30000 N/m
Curve 3500 N
Weight: 8,3 kg/m²
Temp. range: dry -40÷80 °C
wet -40÷65 °C
Pin material: PBT white

MWX - Code 17

Polyamide Composite

Max w. load:
Straight 30000 N/m
Curve 3500 N
Weight: 8,6 kg/m²
Temp. range: dry -40÷104 °C
wet NR
Pin material: PBT white

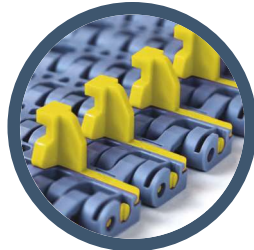

**TAB
DK Material**

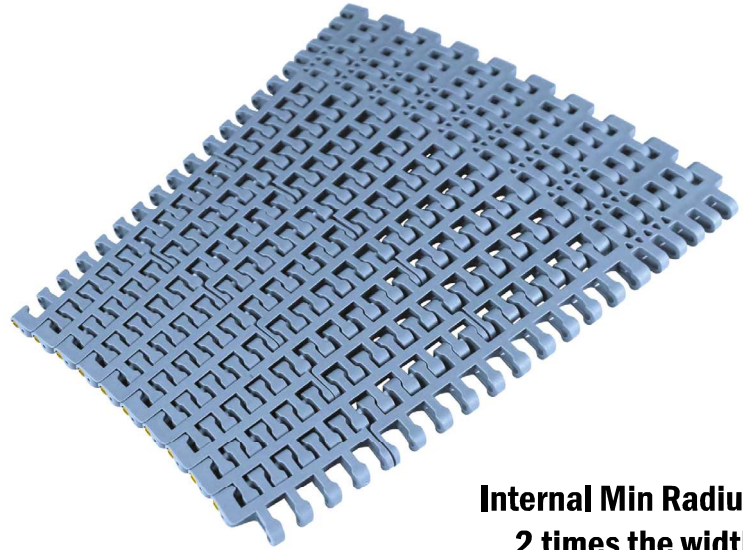

**Internal Min Radius
2 times the width**

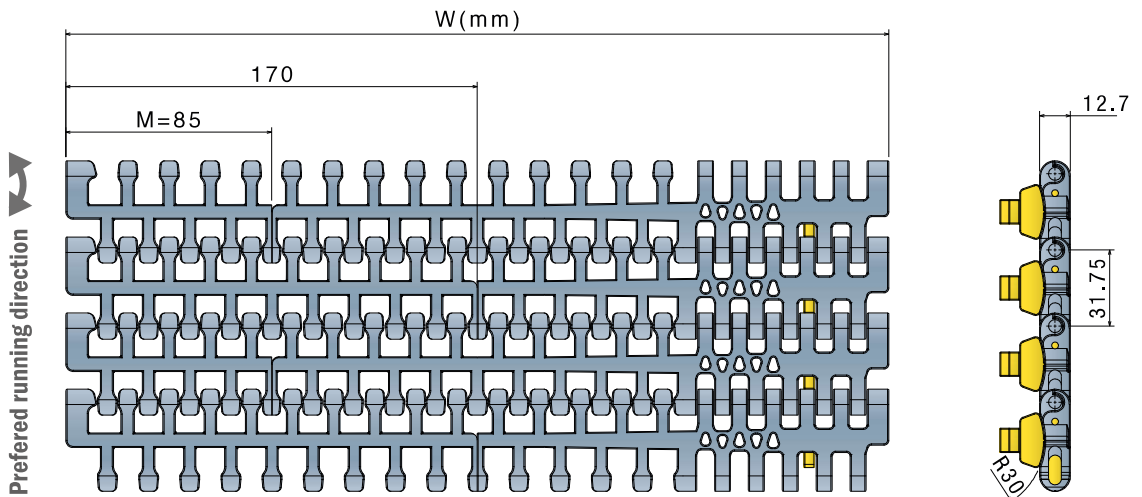

Preferred running direction

STANDARD

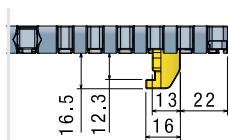

Series	Material	Width	Version	min radius
5422	*	0340	E	680
5422	*	0425	E	850
5422	*	0510	E	1020
5422	*	0595	E	1190
5422	*	0680	E	1360
5422	*	0765	E	1530
5422	*	0850	E	1700

600 Small radius

Tappeti modulari / Modular belts / Mattenketten

600 Small radius

Tappeto Modulare Curvilineo Serie 600, H=12,7 M=85
Side Flex Modular Belt Series 600, H=12,7 M=85 / Kurvengängige Mattenkette Serie 600, H=12,7 M=85

Metric Size

CODE STRUCTURE GUIDE

(Example)

5423	03	0340	A
Series	*Material	Width	Version

Backflex radius min.: 25 mm



pg. 234



pg. 420->428

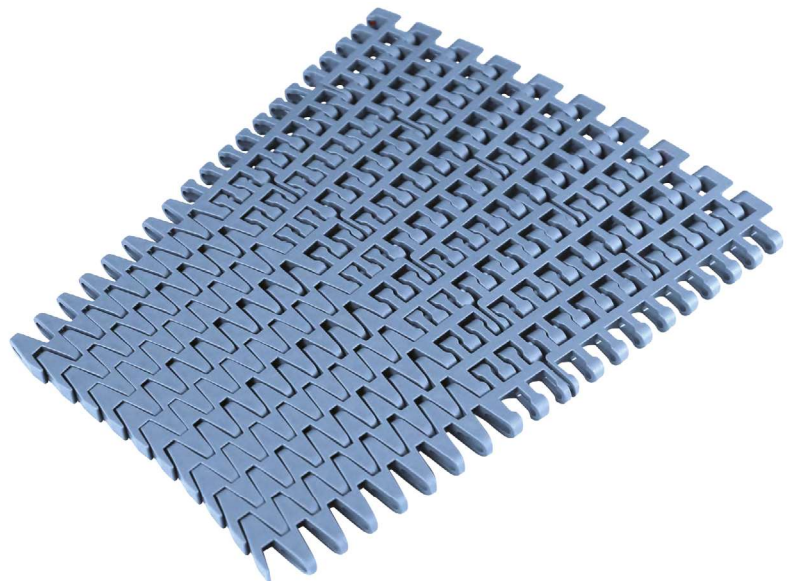

*Material

LFA - Code 01

Low friction Acetal

Max w. load:

Straight 30000 N/m

Curve 2500 N

Weight: 7,0 kg/m²

Temp. range: dry -40+80 °C

wet -40+65 °C

Pin material: PBT white

MX - Code 03

Performance PBT

Max w. load:

Straight 24000 N/m

Curve 2000 N

Weight: 6,8 kg/m²

Temp. range: dry -40+120 °C

wet -40+60 °C

Pin material: POM grey

MK - Code 08

Super Performance Acetal

Max w. load:

Straight 28800 N/m

Curve 2400 N

Weight: 7,0 kg/m²

Temp. range: dry -40+80 °C

wet -40+65 °C

Pin material: PBT white

MPX - Code 25

Lubricated Acetal

Max w. load:

Straight 30000 N/m

Curve 2500 N

Weight: 7,0 kg/m²

Temp. range: dry -40+80 °C

wet -40+65 °C

Pin material: PBT white

DKM - Code 16

Aramid Reinforced Acetal

Max w. load:

Straight 30000 N/m

Curve 2500 N

Weight: 7,0 kg/m²

Temp. range: dry -40+80 °C

wet -40+65 °C

Pin material: PBT white

MWX - Code 17

Polyamide Composite

Max w. load:

Straight 30000 N/m

Curve 2500 N

Weight: 7,3 kg/m²

Temp. range: dry -40+104 °C

wet NR

Pin material: PBT white

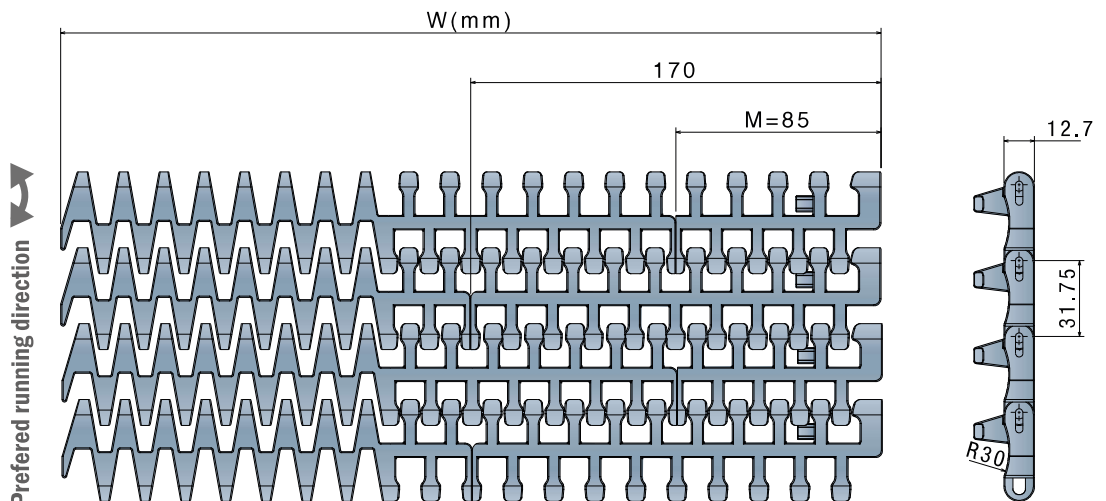

STANDARD



TAB

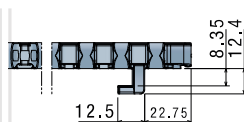

REVERSE TAB

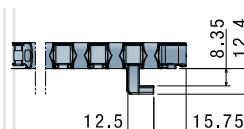

TAB REVERSE TAB

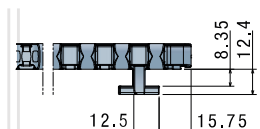

Series	Material	Width	Version	min radius	Series	Material	Width	Version	min radius	Series	Material	Width	Version	min radius	Series	Material	Width	Version	min radius
5423	*	0340	A	400	5423	*	0340	B	400	5423	*	0340	C	400	5423	*	0340	D	400
5423	*	0425	A	500	5423	*	0425	B	500	5423	*	0425	C	500	5423	*	0425	D	500
5423	*	0510	A	600	5423	*	0510	B	600	5423	*	0510	C	600	5423	*	0510	D	600
5423	*	0595	A	720	5423	*	0595	B	720	5423	*	0595	C	720	5423	*	0595	D	720
5423	*	0680	A	880	5423	*	0680	B	880	5423	*	0680	C	880	5423	*	0680	D	880
5423	*	0765	A	1040	5423	*	0765	B	1040	5423	*	0765	C	1040	5423	*	0765	D	1040
5423	*	0850	A	1200	5423	*	0850	B	1200	5423	*	0850	C	1200	5423	*	0850	D	1200

600 Heavy duty/Small radius

Tappeto Modulare Curvilineo Serie 600, H=12,7 M=170
Side Flex Modular Belt Series 600, H=12,7 M=170 / Kurvengängige Mattenkette Serie 600, H=12,7 M=170

Metric Size

CODE STRUCTURE GUIDE

(Example)

5424	03	425	E
Series	*Material	Width	Version

Backflex radius min.: 25 mm



pg. 234



pg. 420->428

* Material

LFA - Code 01

Low friction Acetal

Max w. load:

Straight 30000 N/m

Curve 3500 N

Weight: 7,5 kg/m²

Temp. range: dry -40÷80 °C

wet -40÷65 °C

Pin material: PBT white

MX - Code 03

Performance PBT

Max w. load:

Straight 24000 N/m

Curve 3000 N

Weight: 7,3 kg/m²

Temp. range: dry -40÷120 °C

wet -40÷60 °C

Pin material: POM grey

MK - Code 08

Super Performance Acetal

Max w. load:

Straight 28800 N/m

Curve 3350 N

Weight: 7,5 kg/m²

Temp. range: dry -40÷80 °C

wet -40÷65 °C

Pin material: PBT white

MPX - Code 25

Lubricated Acetal

Max w. load:

Straight 30000 N/m

Curve 3500 N

Weight: 7,5 kg/m²

Temp. range: dry -40÷80 °C

wet -40÷65 °C

Pin material: PBT white

DKM - Code 16

Aramide Reinforced Acetal

Max w. load:

Straight 30000 N/m

Curve 3500 N

Weight: 7,5 kg/m²

Temp. range: dry -40÷80 °C

wet -40÷65 °C

Pin material: PBT white

MWX - Code 17

Polyamide Composite

Max w. load:

Straight 30000 N/m

Curve 3500 N

Weight: 7,7 kg/m²

Temp. range: dry -40÷104 °C

wet NR

Pin material: PBT white

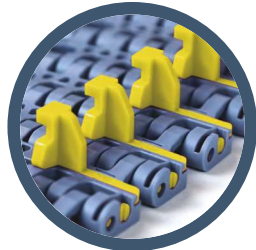

TAB
DK Material

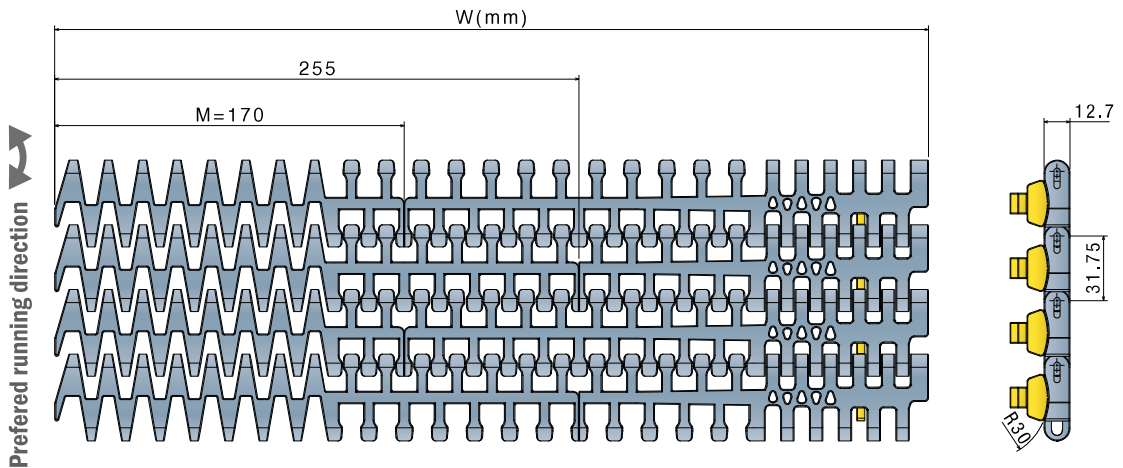
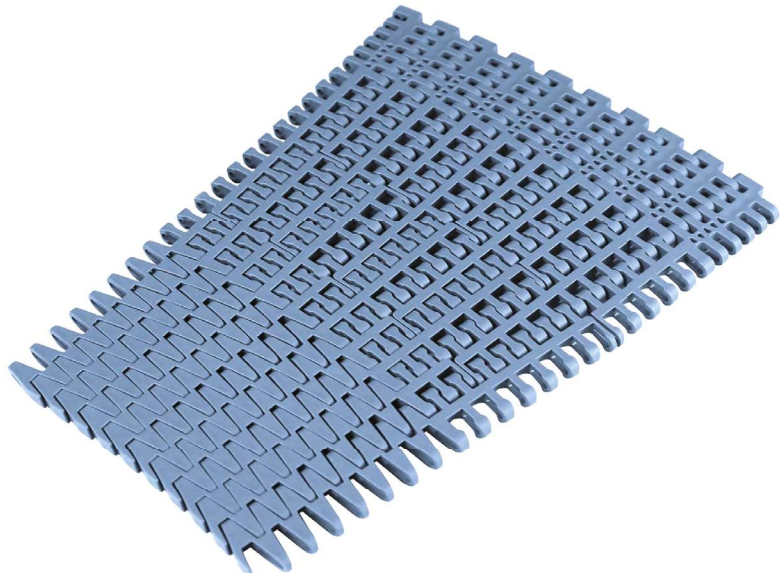

STANDARD

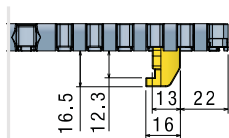

Series	Material	Width	Version	min radius
5424	*	0425	E	500
5424	*	0510	E	600
5424	*	0595	E	720
5424	*	0680	E	880
5424	*	0765	E	1040
5424	*	0850	E	1200

600 with pusher - 1047 Heavy duty guide

Tappeti modulari / Modular belts / Mattenketten

600 with pusher

Tappeto Modulare Curvilineo Serie 600, H=12,7 M=85
Side Flex Modular Belt Series 600, H=12,7 M=85 / Kurvengängige Mattenkette Serie 600, H=12,7 M=85

Metric Size

Consult our engineering department for details.



pg. 234



pg. 420->428

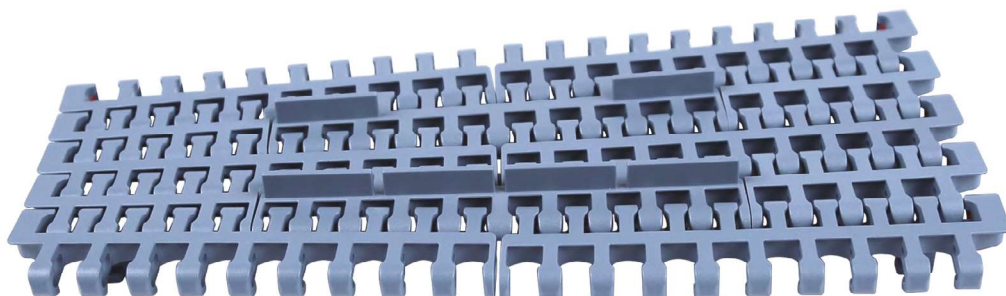

1047

Guida tappeto
Belt side guide / Seitenführung für Mattenkette

Part	Article-Nr.	Width
1047	104700BC	3 m

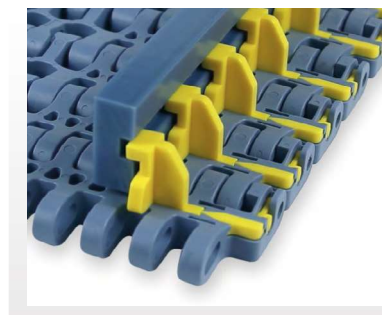
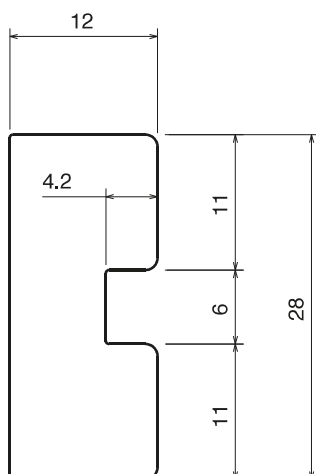

500 Series

500

Imperial Size

Pitch 50,8 mm
H= 24 mm

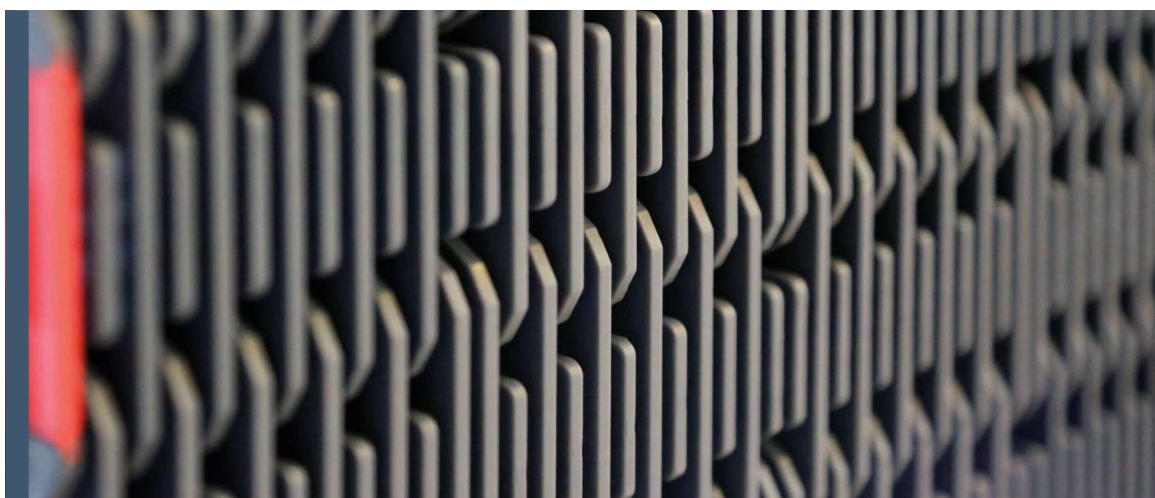

500 RR
Combs

Movex[®]

500 RR

Tappeti modulari / Modular belts / Mattenketten

500 RR

Tappeto Modulare 500 RR
Raised Rib Belt Series 500 RR / Modulare Mattenkette 500 RR

Imperial Size

CODE STRUCTURE GUIDE

(Example)

1348	11	0090	A
Series	*Material	Width	Version



pg. 235



pg. 420->428



* Material

PP - Code 02
Polypropylene

PPX - Code 11
Polypropylene

Max w. load: 30000 N/m
Weight: 10,65 kg/m²
Temp. range: 4+104 °C

Max w. load: 30000 N/m
Weight: 10,65 kg/m²
Temp. range: 4+104 °C

Pin material: PP grey **Pin material:** PP grey

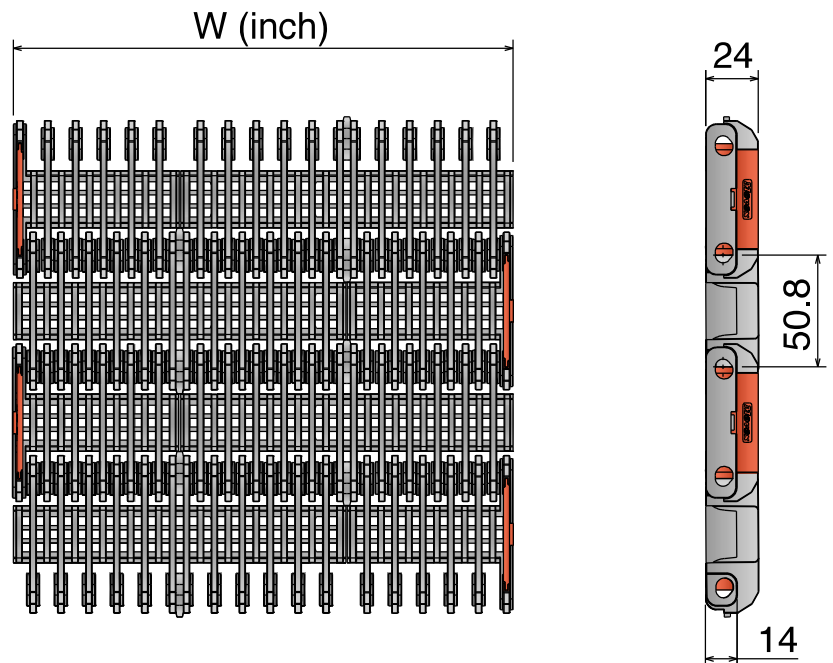

Series	Material	Width	Series	Material	Width
1348	*	0060	1348	*	0093
1348	*	0063	1348	*	0096
1348	*	0066	1348	*	0099
1348	*	0069	1348	*	0102
1348	*	0072	1348	*	0105
1348	*	0075	1348	*	0108
1348	*	0078	1348	*	0111
1348	*	0081	1348	*	0114
1348	*	0084	1348	*	0117
1348	*	0087	1348	*	0120
1348	*	0090			

389 Pettine
Combs / Fingerplatte



Type A

Part	Article-Nr.
389	38901

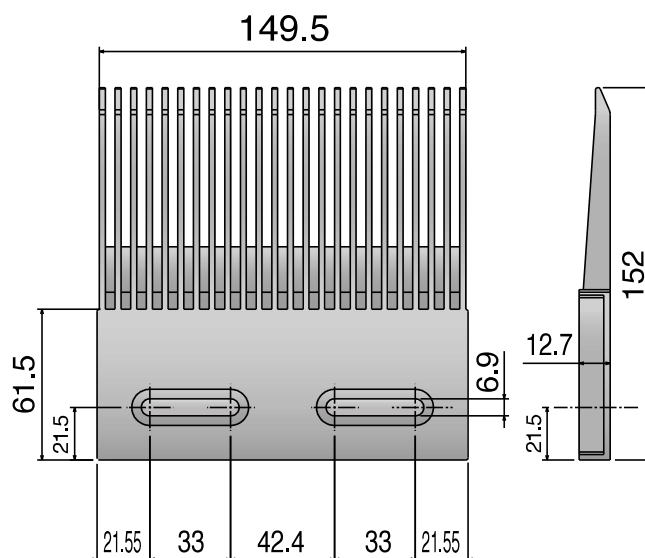

Type B

Part	Article-Nr.
389	38902

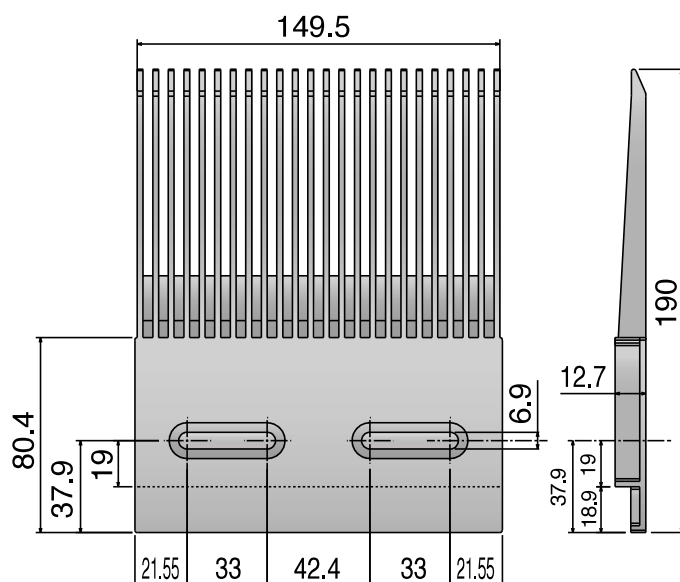

260/261

Metric Size

Pitch 25,4 mm

H= 21 mm / 25 mm / 28,7 mm

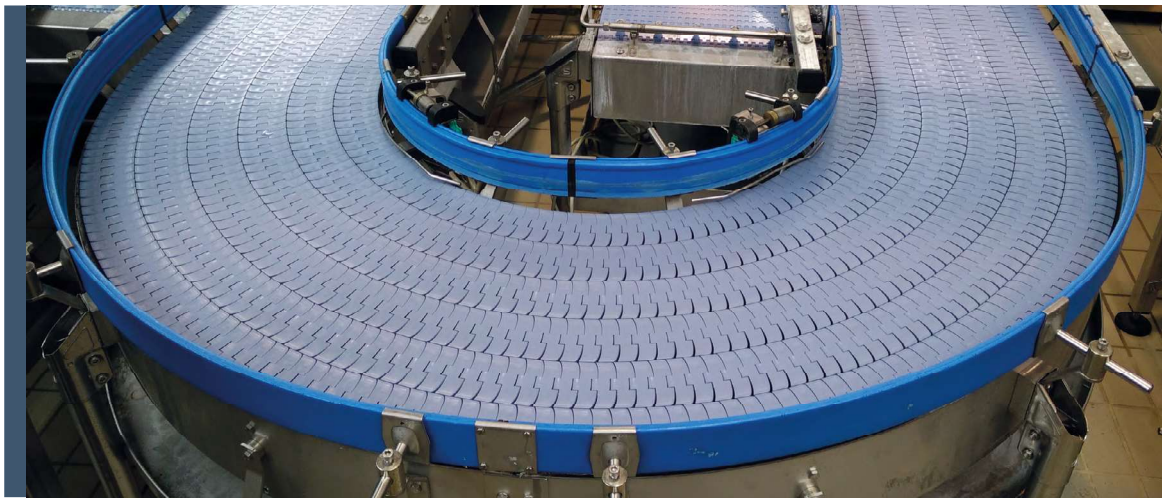

260 M FT

260 M FG

260 TAB

261 M

261 TAB

260 M FT

Catena curvilinea
Sideflexing belt/chain / Kurvengängige Mattenkette

Magnetic System

Part	Article-Nr.	Ref.	A	Weight LFA
1151	11510103	260 M K330	83,8	1,75
1151	11510105	260 M K450	114,3	1,95



pg. 230-231

pg. 125->131

pg. 420->428

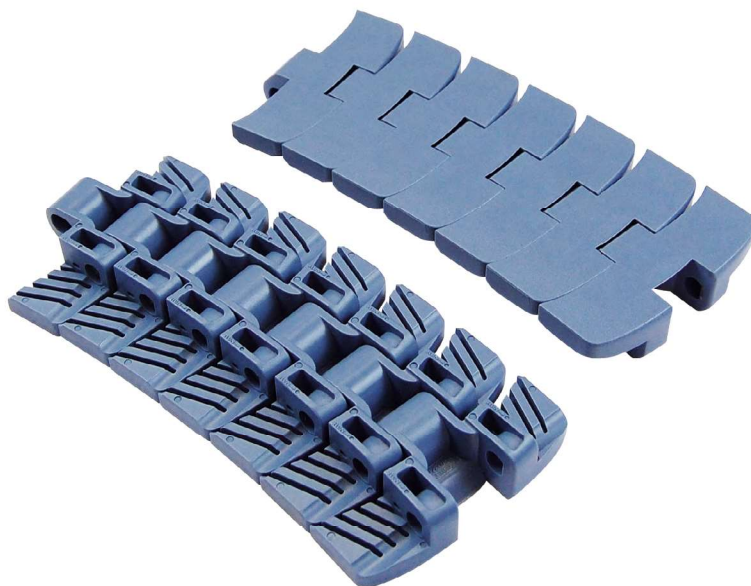

*Material

LFA - Code 01

Low friction Acetal

Max w. load: 2000 N/m
Sideflex radius: 500 mm
Pin material: PBT white

MX - Code 03

Performance PBT

Max w. load: 1600 N/m
Sideflex radius: 500 mm
Pin material: Ferritic SS

MK - Code 08

Super Performance Acetal

Max w. load: 1950 N/m
Sideflex radius: 500 mm
Pin material: Ferritic SS

MPX - Code 25

Lubricated Acetal

Max w. load: 2000 N/m
Sideflex radius: mm
Pin material: Ferritic SS

DKM - Code 16

Aramide Reinforced Acetal

Max w. load: 2000 N/m
Sideflex radius: mm
Pin material: Ferritic SS

MWX - Code 17

Polyamide Composite

Max w. load: 2000 N/m
Sideflex radius: mm
Pin material: Ferritic SS

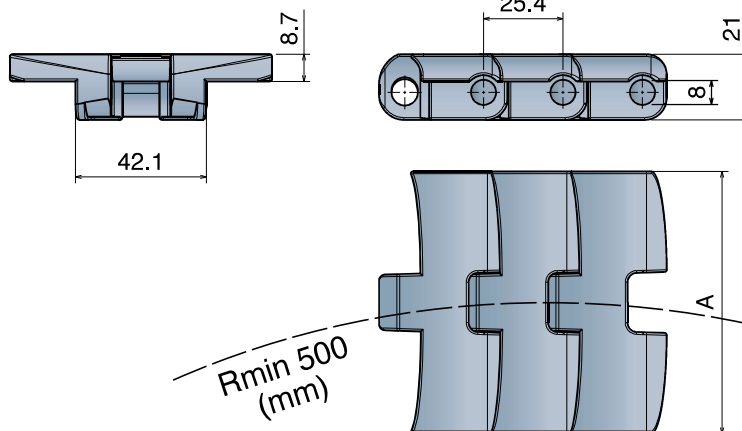

260 M FG

Catena curvilinea
Sideflexing belt/chain / Kurvengängige Mattenkette

Magnetic System

Part	Article-Nr.	Ref.	A	Weight LFA
1154	11540103	260 M FG K330	83,8	1,50
1154	11540105	260 M FG K450	114,3	1,65

 pg. 230-231	 pg. 125->131	 pg. 420->428
---	--	--

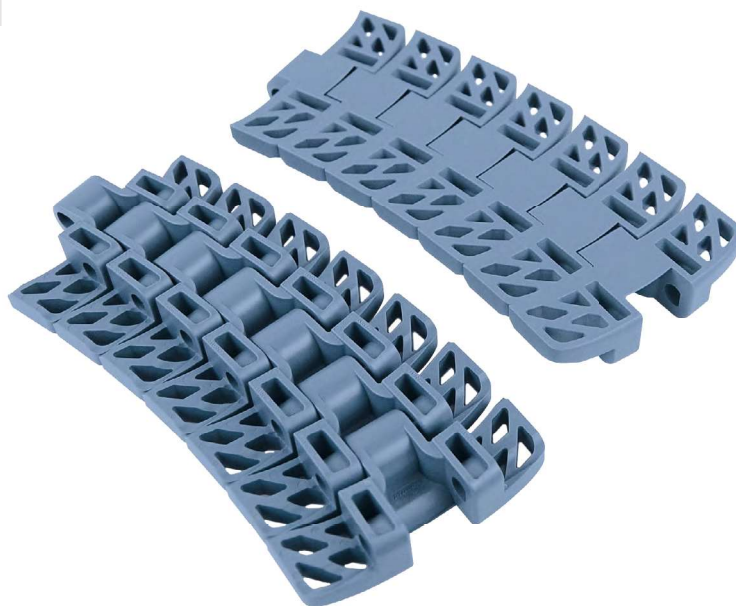

*Material

LFA - Code 01

Low friction Acetal

Max w. load: 2000 N/m
Sideflex radius: 500 mm
Pin material: PBT white

MX - Code 03

Performance PBT

Max w. load: 1600 N/m
Sideflex radius: 500 mm
Pin material: Ferritic SS

MK - Code 08

Super Performance Acetal

Max w. load: 1950 N/m
Sideflex radius: 500 mm
Pin material: Ferritic SS

MPX - Code 25

Lubricated Acetal

Max w. load: 2000 N/m
Sideflex radius: mm
Pin material: Ferritic SS

DKM - Code 16

Aramide Reinforced Acetal

Max w. load: 2000 N/m
Sideflex radius: mm
Pin material: Ferritic SS

MWX - Code 17

Polyamide Composite

Max w. load: 2000 N/m
Sideflex radius: mm
Pin material: Ferritic SS

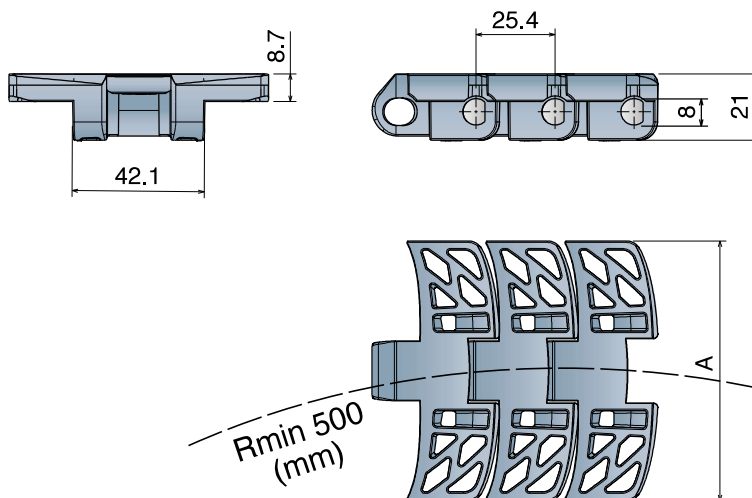

260 TAB Catena curvilinea Sideflexing belt/chain / Kurvengängige Mattenkette

Tab System

Part	Article-Nr.	Ref.	A	Weight LFA
1152	11520103	260 TAB K330	83,8	1,85
1152	11520105	260 TAB K450	114,3	2,00



***Material**

LFA - Code 01

Low friction Acetal

Max w. load: 2000 N/m
Sideflex radius: 500 mm
Pin material: PBT white

MX - Code 03

Performance PBT

Max w. load: 1600 N/m
Sideflex radius: 500 mm
Pin material: Ferritic SS

MK - Code 08

Super Performance Acetal

Max w. load: 1950 N/m
Sideflex radius: 500 mm
Pin material: Ferritic SS

MPX - Code 25

Lubricated Acetal

Max w. load: 2000 N/m
Sideflex radius: mm
Pin material: Ferritic SS

DKM - Code 16

Aramide Reinforced Acetal

Max w. load: 2000 N/m
Sideflex radius: mm
Pin material: Ferritic SS

MWX - Code 17

Polyamide Composite

Max w. load: 2000 N/m
Sideflex radius: mm
Pin material: Ferritic SS

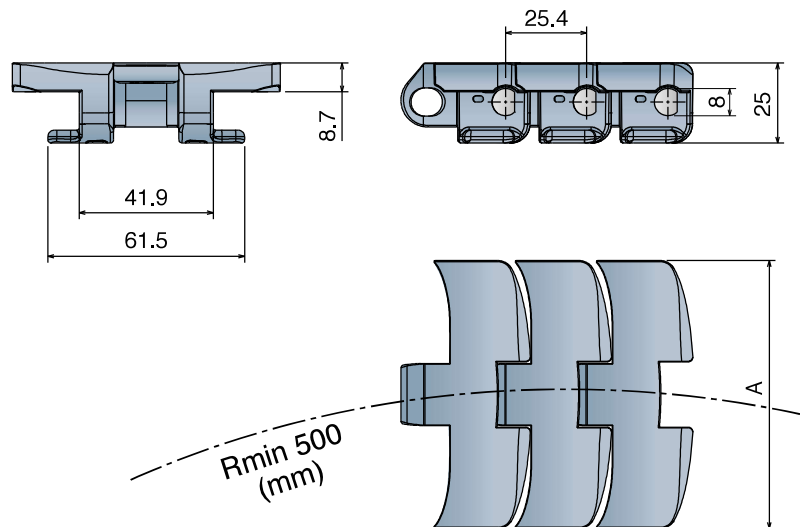

261 M FT

Catena curvilinea
Sideflexing belt/chain / Kurvengängige Mattenkette

Magnetic System

Part	Article-Nr.	Ref.	A	Weight LFA
1153	11530103	260 M K330	83,8	2,10
1153	11530105	260 M K450	114,3	2,26

		
pg. 230-231	pg. 132->138	pg. 420->428

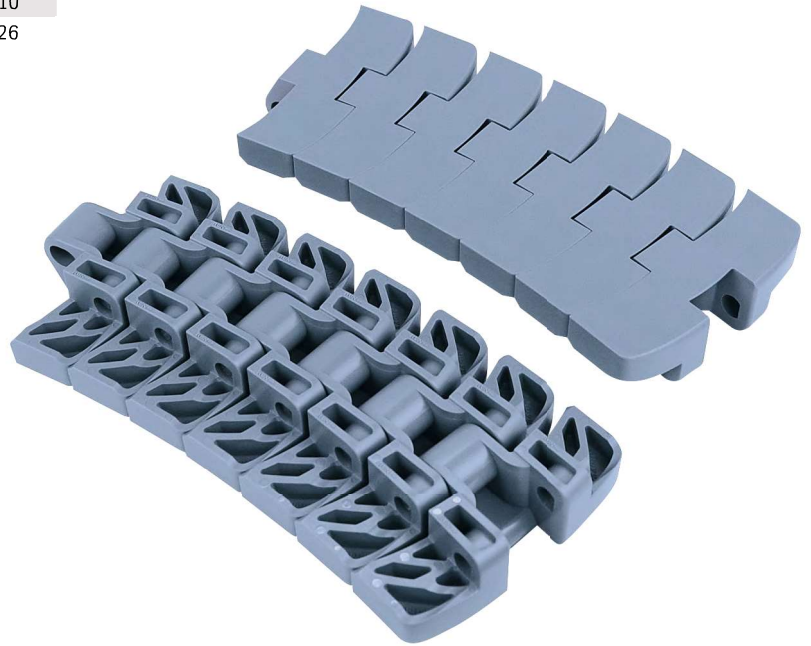

*Material

LFA - Code 01

Low friction Acetal

Max w. load: 2000 N/m
Sideflex radius: 500 mm
Pin material: PBT white

MX - Code 03

Performance PBT

Max w. load: 1600 N/m
Sideflex radius: 500 mm
Pin material: Ferritic SS

MK - Code 08

Super Performance Acetal

Max w. load: 1950 N/m
Sideflex radius: 500 mm
Pin material: Ferritic SS

MPX - Code 25

Lubricated Acetal

Max w. load: 2000 N/m
Sideflex radius: mm
Pin material: Ferritic SS

DKM - Code 16

Aramide Reinforced Acetal

Max w. load: 2000 N/m
Sideflex radius: mm
Pin material: Ferritic SS

MWX - Code 17

Polyamide Composite

Max w. load: 2000 N/m
Sideflex radius: mm
Pin material: Ferritic SS

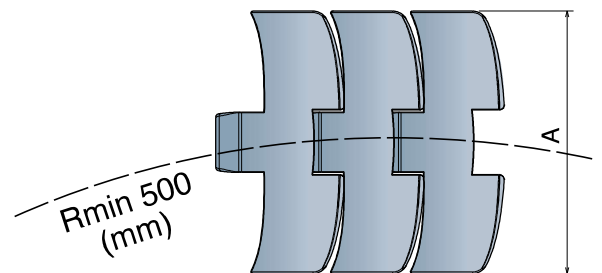
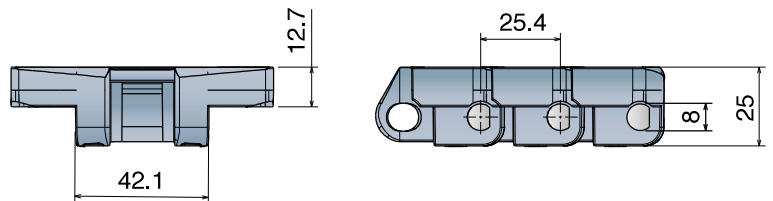

261 TAB

Catena curvilinea
Sideflexing belt/chain / Kurvengängige Mattenkette

Tab System

Part	Article-Nr.	Ref.	A	Weight LFA
1190	11900103	261 TAB K330	83,8	1,85
1190	11900105	261 TAB K450	114,3	2,00



*Material

LFA - Code 01

Low friction Acetal

Max w. load: 2000 N/m
Sideflex radius: 500 mm
Pin material: PBT white

MX - Code 03

Performance PBT

Max w. load: 1600 N/m
Sideflex radius: 500 mm
Pin material: Ferritic SS

MK - Code 08

Super Performance Acetal

Max w. load: 1950 N/m
Sideflex radius: 500 mm
Pin material: Ferritic SS

MPX - Code 25

Lubricated Acetal

Max w. load: 2000 N/m
Sideflex radius: mm
Pin material: Ferritic SS

DKM - Code 16

Aramide Reinforced Acetal

Max w. load: 2000 N/m
Sideflex radius: mm
Pin material: Ferritic SS

MWX - Code 17

Polyamide Composite

Max w. load: 2000 N/m
Sideflex radius: mm
Pin material: Ferritic SS

